



SCE800TB-EV

Electric Telescopic Boom Crawler Crane

Quality Changes the World



Max. lifting moment: 313t · m
Max. boom length: 47m
Max. boom + jib length: 47m+17.5m

The parameters, pictures and standard/optional equipment are only for reference in this brochure, the actual machine is based on the effective price list and contract.



Electric Telescopic Boom Crawler Crane SCE800TB-EV

P03

Main
Characteristics

- Product Specification
- Safety Device

P08

Technical
Parameters

- Major Performance & Specifications
- Outline Dimension
- Transport Dimension
- Transport Plan

P14

Configuration

- Working range of H
- Load Chart of H
- Load Chart of FJ
- Foundation Purposes Load Chart



SCE800TB-EV **ELECTRIC TELESCOPIC BOOM CRAWLER CRANE**

QUALITY CHANGES THE WORLD

Main Characteristics

- Page 04 Product Specification
- Page 07 Safety Device



Product Specification



Power battery

- Cell type: LFP (lithium iron phosphate).
- Battery pack operating voltage: 480-700.8V.
- Rated energy storage: 281.91kWh.
- Max. continuous charging current: Single electric gun: 200A, Dual electric gun: 400A.
- Battery case protection level: IP68.
- Way of battery heat dissipation: Liquid cooling.

Drive motor

- Mode: Danfoss EM-PMI375-T1100-1500.
- Type: Permanent magnet synchronous machine.
- Rated voltage: 600VDC.
- Rated power: 206kW, @65°C.
- Rated speed: 1500r/min.
- Rated torque: 1310N·m.
- Cooling system: Water cooling.

2 in 1 integrated controller

- Integration: High voltage distribution unit(PDU), DC/DC transformer.
- Operating voltage range: 400~750VDC.
- Protection level: IP67.
- Way of controlling: CAN contro.
- DC/DC rated power: 3.5kW.
- High voltage distribution: Including main motor, DC/DC, A/C compressor, PTC, slow charge distribution circuit.

Charge function

- Quick charge: Single charging gun: 200A(continuous), Dual charging gun: 400A(continuous) supported.
- Slow charge: Max.63A (continuous), 125A (optional), charging while working supported.

High voltage safety design

- Electric leakage protection: High voltage of whole machine has real-time insulation monitoring function, able to cut off high voltage circuit initiatively when sudden electric leakage happens and alarms, protecting high voltage safety.
- Alarm of battery overheating out of control: When the power battery is overheated and out of control, the battery system can not catch fire or explode at least 5 minutes, and at the same time, alarm signals are sent tout on the display screen to reserve time for the driver to escape.
- Shielding and shell electric shock protection: the shell connector of high voltage components meet IPXXB (Finger touch prevention).
- High voltage interlock: Real-time monitor the interlocking status of high-voltage connectors on high -voltage components , give an alarm and forbid high-voltage power-on when interlocking is abnormal.
- Waterproof and dustproof: The waterproof and dustproof grade of all high-voltage components shall not be lower than IP67.

SANY developed SYIC-III integrated control system is adopted with high integration, precise operation and reliable quality

- Power battery system: The main control and she slave control in each battery pack adopt daisy-chain communication to achieve power in real time and efficient battery system data acquisition and control.
- Drive motor system: Vector control is adopted to achieve high precision control of motor output overload, over temperature, short circuit, over voltage protection and other functions.
- Control system: Power battery system, drive motor system, power supply system and main control system, torque limiter system, auxiliary system and safety monitoring system. The controller, CAN bus technology is applied between display, power battery system and drive motor system line data communication.
- Display: Can display power battery SOC, power battery voltage, power battery charge and discharge current, instantaneous power of driving motor, charging mark, lifting weight and boom Angle and other working parameters number and working status.

Main/aux. load hoist mechanism

- Pump and motor: dual variable displacement with speed adjustable, to realize higher efficiency and lower down the energy. Winch balance valve combined with anti-hook sliding technology can make sure the load lifting steady.
- Winch brake adopts wet type and spring loaded fin type normally engaged brake, spring force braking, oil pressure released.
- Main and aux. load hoist system adopts piston motor of variable displacement to drive planetary gearbox.

Main Load Hoist Winch	Rope speed on the outermost layer	0 - 140m/min
	Wire rope diameter	Φ22mm
	Wire rope length	245m
	Rated single line pull	8.0t
Axu. Load Hoist Winch	Rope speed on the outermost layer	0 - 140m/min
	Wire rope diameter	Φ22mm
	Wire rope length	145m
	Rated single line pull	8.0t



Product Specification

Boom hoist mechanism

- dual-acting single piston hydraulic cylinder, with safety balance valve, and a luffing angle of $-2^{\circ}\sim 80^{\circ}$. Luffing down through self-weight to reduce energy consumption and increase stability of luffing down operation.

Slewing mechanism

- Slewing brake adopts wet, spring loaded, normally-closed brake, and braking through spring force.
- Slewing system, equipped with integrated slewing buffer valve, has free slipping function. It is featured in steady start, control and excellent inching function.
- Unique slewing buffer design and more steady brake.
- Slewing drive: External gear slewing drive with 360° slewing range, and the max. slewing speed is 2r/min. The max. drive pressure can reach 20MPa.
- Slewing lock: Cylinder lock device can make sure the upperworks can be locked on four directions after the work is done or during transport, which is more convenient and reliable.
- Slewing ring: Single row ball bearing.

Counterweight

- Counterweight are designed into blocks for self-assembly and easier transport.
- Counterweight tray and blocks are piled up for easier assembly and transport.
- Rear counterweight: Total 26t and capable of self-assembly.
- Carbody counterweight: 3t \times 2 at the front and rear of carbody.

Upperworks

- High-strength steel weld framework, with no torsion or deformation. The parts are laid out in the way that is easier for maintenance and service.

Cab and controls

- Intelligent cockpit: One-button start and stop: One-button operation, more convenient.
 - Auxiliary appliances: Air conditioning, radio, etc. can realize voice + button dual-mode control.
 - Headlights can be voice + remote control + button + automatic four-mode control; wiper can be voice + button + automatic three mode control. Can effectively free hands.
 - Power wake up: Remote control + local + emergency three modes, meet different scenarios.
 - Fault broadcast: Fault broadcast in real time and prompt customers in time.
 - Video shows: Video display: The video follows the switching technology, the picture can see more clearly.
 - Zoom control: Gesture control + epad dual mode, more convenient operation.
 - Video quantity: Access to a maximum of 9 channels of video, all-round monitoring.
 - Video storage: More than 72 hours of record.
 - Identification of tangled rope: Built-in identification of lifting and winching tangled rope, easy to operate.
 - Human interaction: 10.1-inch touch screen.
 - Interface simplification: Low-level human-machine interface, Tesla-level experience.
 - Data display: Key data are highlighted for easy observation.
 - Fault display: Pop-up fault alarm to prevent missing fault.
 - Dynamic screen: The first dynamic display of the whole machine model, more image data.
- ### Comfortable:
- Constant temperature air conditioning: Adaptive ambient temperature + surrounding air duct, more comfortable.
 - Bluetooth music: Mobile phone interconnection + intelligent off, richer and safer entertainment; car phone: one button to answer/hang up, convenient, fast and safe.
 - Charging mode: USB charging + cigarette lighter charging dual mode, rich choice.

Product Specification



Travel drive

- Independent travel driving units are adopted for each side of the crawler, to realize straight walking and turning driven by travel motor through gearbox and drive wheel.
- There are high-speed and low-speed for travel as fast as 2.5km/h.
- Gradeability is 30%.

Travel brake

- Embedded, wet, spring-loaded and normally-closed brake, which is braking with spring force and released by oil pressure.

Crawler extension and retraction

- The crawlers can extend and retract under high pressure provided by auxiliary system and electrically-controlled cylinder. During normal operation, the crawlers must be extended, and can be retracted during transport to stay on the machine.

Crawler tensioning

- The jack is used to push the guide wheel and insert the shim to adjust crawler tension.

Steering system

- The machine is capable of pivot turning and single track turning.

Track pad

- High-strength alloy cast steel track pad can prolong the service life. They are 850mm wide, and the total amount is 63pcs×2.

Track roller

- Maintenance-free track roller.

Outrigger

- Outrigger cylinder is offered to facilitate the track frame disassembly during jobsite transfer.

Boom

- The boom is made of high-strength steel structure with U-shape section area, with five sections, of which the basic boom is 12.2m and the total length is 47m.
- Dual cylinder full power rope row telescoping.

Fixed jib

- Two lengths of fixed jib, 10.2m and 17.5m, each can be installed in angle 0°, 15°, 30°.

Boom point sheave block

- Weld structures, connected to the boom through pins and used for aux. hook.

Hook block

SN	Load Capacity	Sheave	Weight	QTY
1	80t hook	5	1.05t	1
2	45t hook (optional)	3	0.49t	1
3	15t hook (optional)	1	0.28t	1
4	9t ball hook	0	0.16t	1

- Note: the above-mentioned operating equipment is full-up configuration. The actual configurations are subject to contract.

Hook limitation height

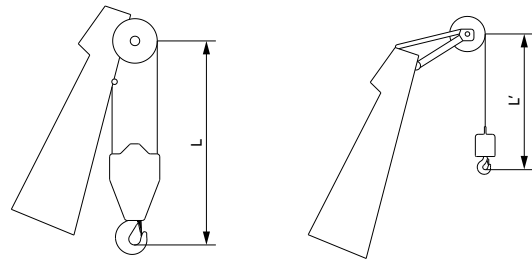

Hook	L	Hook	L'
80t	3.5m	9t	3m



Safety Device

Integrated LMI control system

- LMI control system is standard offering and it is calibration-free. It ensures the operation safety and improves efficiency.
- LMI system can automatically detect the load weight, working radius and boom angle, to compare with rated load weight and actual load, work radius and boom angle. In normal operation, it can make judgment and cut off the actions towards dangerous directions. It also acts as black box to record overload information.
- Composition: Monitor, controller, length and angle sensor, pressure sensor.

Assembly/work mode control switch

- In assembly mode, the over-hoist protection, LML are all off work to facilitate crane assembly.
- In work mode, all safety devices activate to protect the operation.

Emergent stop

- In emergent situation, this button is pressed down to cut off the power supply of whole machine and all actions stop.

Over-hoist protection of the main/auxiliary hooks

- Height limit device is installed at the tip of main boom and jib, which prevents the hook lift up too much. When the hook lifts up to the limit height, the limit switch activates, buzzer on the left control panel sends alarm, and failure indicator light starts to flash, the hook hoisting action is cut off automatically.

Over-release protection device of the main/auxiliary winch

- Three-wrap protector is installed on main and aux. load hoist winches to prevent over-release of wire rope. When the rope is paid out close to the last three wraps, the limit switch acts, and the system sends alarm through buzzer and show the alarm on the instrument panel, automatically cutting off the winch action.

Function lock

- If the function lock level is not in work position, all the other handles won't work, which prevents any mis-operation caused by accidental collision.

Slewing lock

- Electrical lock is equipped, and slewing action can only happen when the lock is released, so as to prevent any operational error and ensure the safety.
- The cylinder lock can lock the upperworks at four directions.

Hook latch

- The lifting hook is installed with a baffle plate to prevent wire rope from falling off.

Monitoring system

- Remote monitoring system is a standardized offering to provide functions like GPS locating, GPRS data transfer, machine status inquiry and statistics, operating data monitoring and analysis, remote diagnosis of failures.

Tri-color load indicator

- The load indication light has three colors, green, yellow and red, indicating the real-time load. When the actual load is smaller than 90% of rated load, the green light is on.
- When the actual load is $>90\%$ and $\leq 100\%$, the yellow light is on, the alarm light flashes and sends out intermittent sirens.
- When the actual load reaches 100% of rated load, the red light on, the alarm light flashes and sends out continuous sirens.
- When the actual load is 102% of rated load, the system will automatically cut off the crane's dangerous operation.

Flash alarm

- When the LMI system is powered on, the flash alarm starts to flash.

Slewing indicator light

- The slewing indicator light flashes during traveling or slewing.

Seat interlock protection

- If the operator leaves the seat, all control handles will be locked immediately to prevent any mis-operation due to accidental collision.

Illuminating light

- The machine is equipped with, low-beam light in front of machine, lamps in operator's cab and boom lights, so as to increase the visibility during work.

Rearview mirror

- It is installed on the front of the operator's cab and the handrail of the right platform and the winch.

Electronic level gauge

- It can show the upperworks tipping angle on the monitor.

Monitor system

- Two cameras and illumination lights are installed on the tail of rotating bed, which will show the conditions on the rear and winches on the monitor.

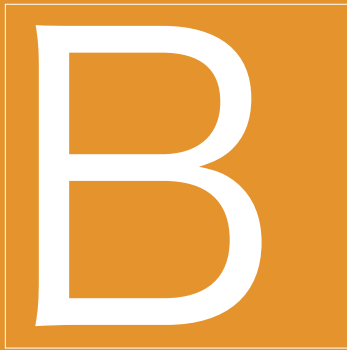

SCE800TB-EV **ELECTRIC TELESCOPIC BOOM CRAWLER CRANE**

QUALITY CHANGES THE WORLD

Technical Parameters

- Page 09 Major Performance & Specifications
- Page 10 Outline Dimension
- Page 11 Transportat Dimension
- Page 13 Transport Plan

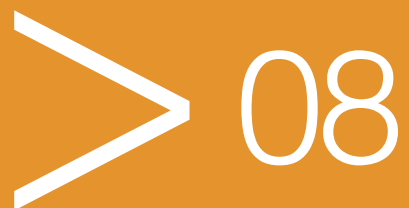

Major Performance & Specifications

Major Performance & Specifications of SCE800TB-EV			
Performance indicators		Unit	Parameter
Outline dimension	Machine length	mm	15410
	Machine width (retracted)	mm	5100 (3490)
	Machine height	mm	3663
	Distance of centers between drive and idle wheels	mm	5600
	Track shoe width	mm	850
Boom configuration	Maximum rated load capacity	t	80
	Boom length	m	12.2~47
	Boom angle	°	-2~+80
	Max. rated load moment	t·m	313
Jib configuration	Longest boom + longest jib	m	47+17.5
	Boom to jib angle	°	0、15、30
Operation speed	Rope speed of main/aux. load hoist	m/min	0~140
	Boom full up/down duration	s	80/105
	Boom full extension/retraction duration	s	100/125
	Slewing speed	rpm	0~2
	Travel without load	km/h	0~2.5
Power	Motor	-	EM-PMI375-T1100-1500
	Rated power	kW/rpm	206/1500
Battery	Model	-	Lithium iron phosphate battery (LFP)
	Rated capacity	kWh/rpm	281.9
	Rated voltage	V	618.24
Charging system	DC quick acting charging	kW	120/240 (single/dual nozzle)
	AC charging	kW	10/20/40/80 (optional)
Wire rope	Diameter	mm	Φ22
Transport parameter	Machine weight	t	91.92
	Weight of largest single piece	t	39.52
	Transport dimensions of basic crane (dismantling crawler frame) length×width×height	mm	15410×3000×3350
Other parameters	Average ground bearing pressure (base boom)	MPa	0.09
	Min. slewing radius	mm	4574

Outline Dimension

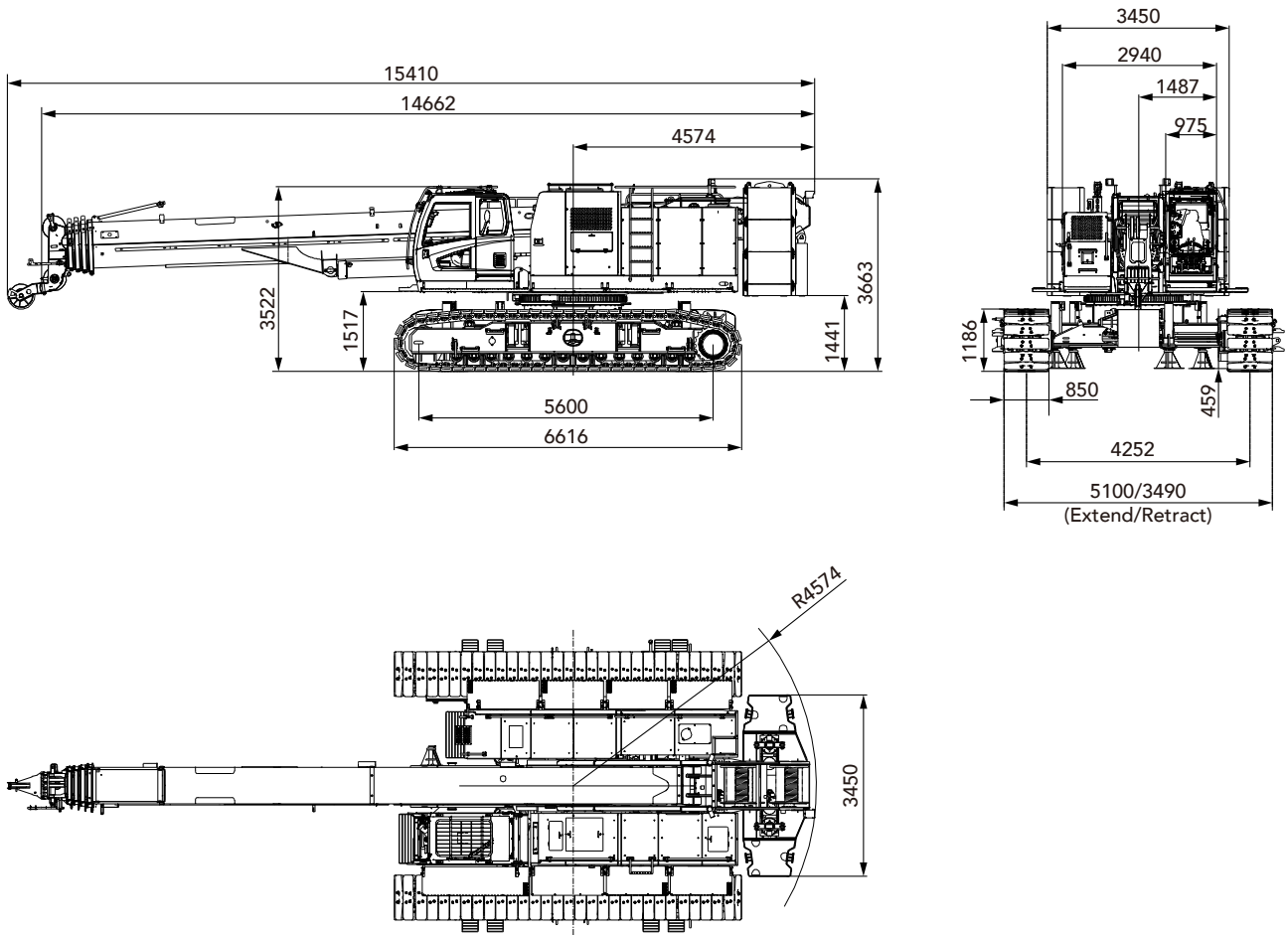

Transport Dimension

Remarks:

- ① . The transport dimensions of each part in the table are schematic, not proportional to the real parts. The dimensions are designed value without packing.
- ② . The Weight is designed value that the actual manufactured part may deviate a little. The total weight of counterweight is 26t.
- ③ . The above dimensions and weight is subject to change due to product upgrading.

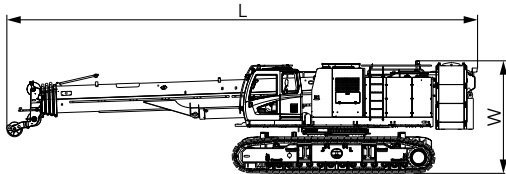

Whole machine (full-counterweight) ×1

Length (L)	15.41m
Width (W)	3.49m
Height (H)	3.66m
Weight	91.92t

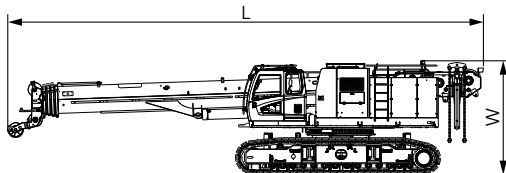

Basic machine (with jib) ×1

Length (L)	15.41m
Width (W)	3.49m
Height (H)	3.66m
Weight	59.92t

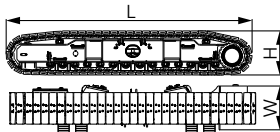

Track frame ×2

Length (L)	6.62m
Width (W)	1.08m
Height (H)	1.18m
Weight	10.2t

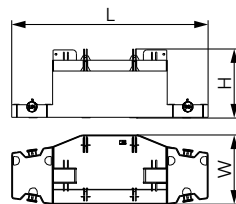

Counterweight tray ×1

Length (L)	3.45m
Width (W)	1.22m
Height (H)	1.21m
Weight	11.6t

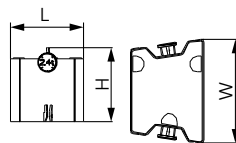

Rear counterweight 1 ×6

Length (L)	0.70m
Width (W)	1.00m
Height (H)	0.71m
Weight	2.4t

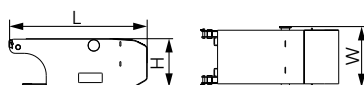

Carbody counterweight ×2

Length (L)	2.03m
Width (W)	0.90m
Height (H)	0.72m
Weight	3.0t

Transport Dimension

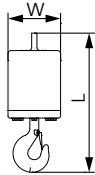

9t hook block

×1

Length (L)	0.68m
Width (W)	0.33m
Height (H)	0.33m
Weight	0.16t

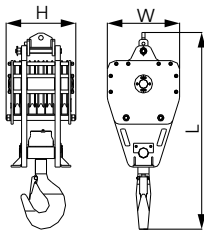

80t hook block

×1

Length (L)	1.86m
Width (W)	0.69m
Height (H)	0.66m
Weight	1.05t

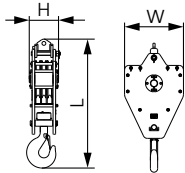

45t hook (optional)

×1

Length (L)	1.52m
Width (W)	0.69m
Height (H)	0.37m
Weight	0.49t

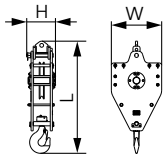

15t hook (optional)

×1

Length (L)	1.34m
Width (W)	0.60m
Height (H)	0.35m
Weight	0.28t

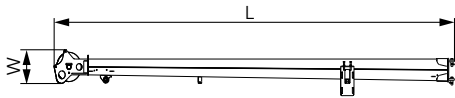

7m slewing-away

×1

Length (L)	7.24m
Width (W)	0.38m
Height (H)	0.51m
Weight	0.26t

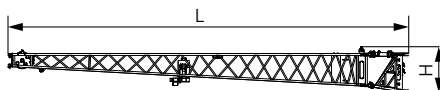

10m jib section

×1

Length (L)	10.68m
Width (W)	0.76m
Height (H)	1.22m
Weight	0.69t

Transport Plan

Total width	▪ 3000mm
Part (s)	▪ Basic machine ×1
Weight	▪ 39.52t

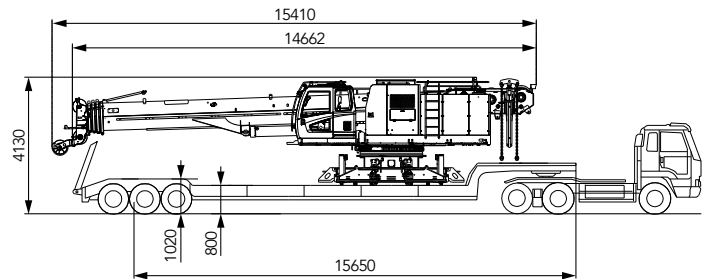

Total width	▪ 3000mm
Part (s)	▪ Carbody counterweight ×2 ▪ Left crawler ×1 ▪ Right crawler ×1 ▪ 80t hook block ×1 ▪ 45t hook block ×1 ▪ 15t hook block ×1 ▪ 9t ball hook ×1
Weight	▪ 28.38t

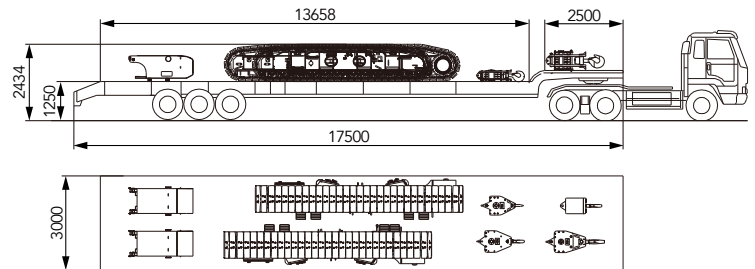

Total width	▪ 3000mm
Part (s)	▪ Counterweight tray ×1 ▪ Rear counterweight ×6
Weight	▪ 26t

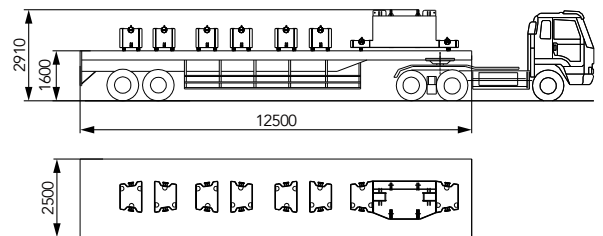



SCE800TB-EV **ELECTRIC TELESCOPIC BOOM CRAWLER CRANE**

QUALITY CHANGES THE WORLD

Configurations

- Page 15 Working Range of H
- Page 16 Load Chart of H
- Page 40 Load Chart of FJ
- Page 42 Foundation Purposes Load Chart

> 14

Working range of H

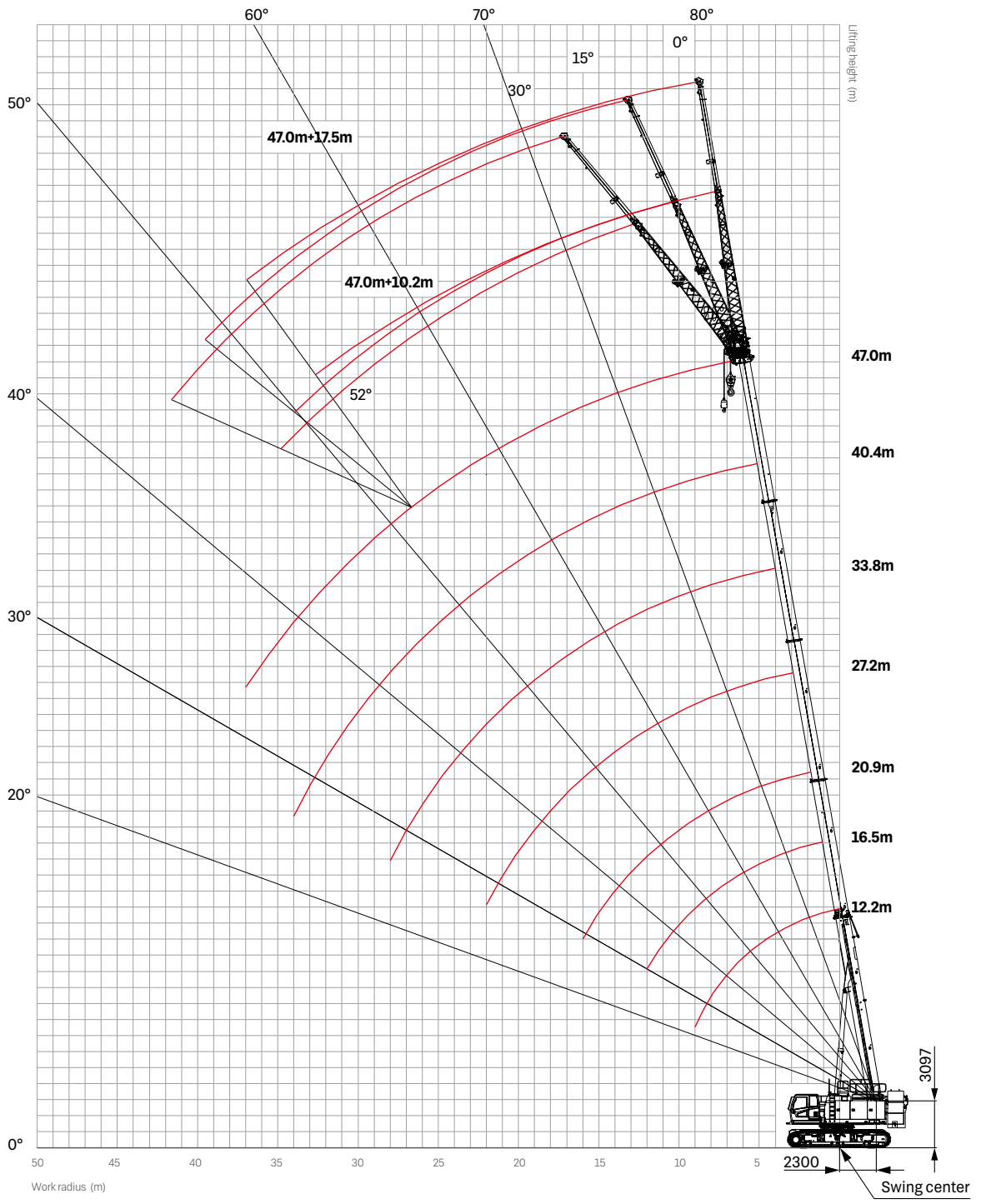

Load Chart of H

H Load Chart
Rear Counterweight 26t, Carbody Counterweight 6t, Track Gauge 2.64m (Crawlers Retracted),
Ground Level 0~1°

Radius (m)	Boom length (m)															Radius (m)
	12.2	16.5	18.7	20.9	23	25.2	27.2	29.5	31.8	33.8	36	38.3	40.4	42.5	47	
3	77.5	65.0														3
3.5	60.3	53.4														3.5
4	55.1	49.5	30.0	43.0												4
4.5	43.2	40.0	30.0	36.5												4.5
5	40.0	38.4	30.0	35.3	30.0	27.0										5
5.5	32.0	31.1	30.0	29.1	29.8	26.0										5.5
6	30.3	30.0	29.0	28.7	29.0	25.0	27.5	25.0								6
6.5	24.7	24.4	26.1	23.7	25.2	24.5	24.0	23.6								6.5
7	24.0	23.7	25.5	23.5	24.9	24.0	23.2	21.0	19.0	22.0						7
7.5	19.8	19.5	21.2	19.4	20.7	22.1	20.2	20.3	18.0	19.8						7.5
8	19.6	19.3	21.1	19.1	20.6	21.8	19.9	20.7	17.0	19.4	18.0					8
9	16.3	16.0	17.8	15.8	17.3	18.4	16.9	18.0	16.0	17.0	16.8		15.8			9
10		13.5	15.2	13.3	14.7	15.9	14.4	15.4	15.0	15.0	15.6	11.0	14.7	11.0		10
11		11.5	13.2	11.4	12.7	13.8	12.4	13.4	14.0	13.1	13.8	10.5	13.1	10.8	11.0	11
12		9.9	11.5	9.7	11.1	12.2	10.8	11.8	12.6	11.4	12.2	10.2	11.8	10.5	11.0	12
14			9.0	7.3	8.6	9.7	8.3	9.2	10.0	8.9	9.6	9.6	9.3	9.9	9.6	14
16				5.5	6.8	7.8	6.5	7.4	8.2	7.1	7.8	8.4	7.5	8.1	7.8	16
18					5.4	6.4	5.1	6.0	6.8	5.7	6.4	7.0	6.1	6.7	6.4	18
20						5.3	4.0	4.9	5.7	4.6	5.3	5.9	5.0	5.6	5.3	20
22							3.1	4.0	4.8	3.7	4.4	5.0	4.1	4.7	4.4	22
24								3.3	4.1	3.0	3.7	4.3	3.4	4.0	3.7	24
26									3.5	2.4	3.1	3.7	2.8	3.3	3.1	26
28										1.9	2.6	3.2	2.3	2.8	2.6	28
30											2.1	2.7	1.8	2.4	2.1	30
32												2.3	1.5	2.0	1.7	32
34													1.1	1.6	1.4	34
36															1.1	36
38																38
40																40
42																42
44																44
n	10	9	4	6	4	4	4	4	3	3	3	2	2	2	2	n
S2	0	50	0	100	50	0	100	50	0	100	50	0	100	50	100	S2
S3	0	0	25	0	25	50	25	50	75	50	75	100	75	100	100	S3
S4	0	0	25	0	25	50	25	50	75	50	75	100	75	100	100	S4
S5	0	0	25	0	25	50	25	50	75	50	75	100	75	100	100	S5

Unit: t

Load Chart of H

H Load Chart Rear Counterweight 26t, Carbody Counterweight 6t, Track Gauge 2.64m (Crawlers Retracted), Ground Level 4°																
Radius (m)	Boom length (m)															Radius (m)
	12.2	16.5	18.7	20.9	23	25.2	27.2	29.5	31.8	33.8	36	38.3	40.4	42.5	47	
3	62.5															3
3.5	60.3															3.5
4	55.1	47.1														4
4.5	43.1	38.9														4.5
5	39.6	38.4	25.0	31.5												5
5.5	31.6	31.0	24.9	30.1												5.5
6	30.0	29.7	24.2	28.7	22.9	20.6										6
6.5	24.4	24.2	23.4	23.6	21.9	19.6										6.5
7	23.7	23.5	22.7	23.2	21.2	18.7	20.9									7
7.5	19.6	19.4	21.0	19.1	20.2	18.1	20.4									7.5
8	19.4	19.1	20.9	18.9	19.6	17.3	19.9	18.3	12.6							8
9	16.1	15.9	17.6	15.7	17.1	15.9	16.8	17.1	12.0	15.2	11.2					9
10		13.4	15.1	13.2	14.6	14.9	14.3	15.3	11.3	14.3	10.5	8.3				10
11		11.4	13.0	11.2	12.6	13.7	12.3	13.3	10.5	12.9	10.0	7.9	9.8	3.9		11
12		9.8	11.4	9.6	11.0	12.1	10.7	11.6	9.8	11.3	9.4	7.4	9.4	3.7		12
14			8.9	7.2	8.5	9.6	8.2	9.1	9.3	8.8	8.5	6.8	8.6	3.3	3.3	14
16				5.4	6.7	7.7	6.4	7.3	8.1	7.0	7.6	6.1	7.4	3.0	3.0	16
18					5.3	6.4	5.0	5.9	6.7	5.6	6.3	5.6	6.0	2.8	2.8	18
20						5.3	4.0	4.9	5.6	4.6	5.2	5.0	5.0	2.6	2.6	20
22							3.1	4.0	4.7	3.7	4.4	4.7	4.1	2.3	2.4	22
24								3.3	4.0	3.0	3.6	4.2	3.4	2.0	2.3	24
26									3.4	2.4	3.0	3.6	2.8	1.9	2.1	26
28										1.8	2.5	3.1	2.2	1.6	1.6	28
30											2.1	2.7	1.8	1.4	1.4	30
32												2.3	1.4	1.2	1.2	32
34													1.1	1.0	1.0	34
36															0.8	36
38																38
40																40
42																42
44																44
n	8	6	4	4	3	3	3	3	2	2	2	2	2	1	1	n
S2	0	50	0	100	50	0	100	50	0	100	50	0	100	50	100	S2
S3	0	0	25	0	25	50	25	50	75	50	75	100	75	100	100	S3
S4	0	0	25	0	25	50	25	50	75	50	75	100	75	100	100	S4
S5	0	0	25	0	25	50	25	50	75	50	75	100	75	100	100	S5

Load Chart of H

H Load Chart
Rear Counterweight 26t, Carbody Counterweight 6t, Track Gauge 3.445m (Crawlers Half Extended),
Ground Level 0~1°

Radius (m)	Boom length (m)															Radius (m)
	12.2	16.5	18.7	20.9	23	25.2	27.2	29.5	31.8	33.8	36	38.3	40.4	42.5	47	
3	80.0	65.0														3
3.5	75.0	63.0														3.5
4	68.0	61.0	30.0	43.0												4
4.5	56.9	51.7	30.0	42.5												4.5
5	52.6	49.2	30.0	42.0	30.0	27.0										5
5.5	41.7	40.0	29.0	37.1	30.0	26.0										5.5
6	39.1	38.7	29.0	36.5	29.0	25.0	30.0	25.0								6
6.5	31.7	31.4	29.0	30.3	29.0	24.5	29.0	24.5								6.5
7	30.6	30.3	29.0	30.1	29.0	24.0	28.0	24.0	19.0	22.0						7
7.5	25.2	25.0	26.7	24.8	26.0	23.1	24.6	23.5	18.0	21.0						7.5
8	24.9	24.6	26.5	24.4	25.9	22.8	22.0	23.0	17.0	20.0	18.0					8
9	20.7	20.4	22.2	20.2	21.7	21.5	21.4	22.0	16.0	18.8	16.8		15.8			9
10		17.2	19.0	17.1	18.5	19.7	18.2	19.2	15.0	17.5	15.6	11.0	14.8	11.0		10
11		14.8	16.5	14.6	16.0	17.2	15.7	16.7	14.0	16.2	14.5	10.5	13.6	10.8	11.0	11
12		12.8	14.5	12.6	14.0	15.1	13.7	14.7	13.2	14.3	13.6	10.2	12.5	10.5	11.0	12
14			11.4	9.6	11.0	12.1	10.6	11.6	11.6	11.3	12.0	9.6	11.0	10.2	10.0	14
16				7.4	8.8	9.8	8.4	9.4	10.2	9.1	9.8	8.8	9.5	9.8	9.0	16
18					7.1	8.2	6.8	7.7	8.5	7.4	8.1	8.0	7.8	8.4	8.1	18
20						6.8	5.5	6.4	7.2	6.1	6.8	7.3	6.5	7.1	6.8	20
22							4.5	5.4	6.2	5.1	5.8	6.4	5.5	6.0	5.8	22
24								4.5	5.1	4.2	4.9	5.5	4.6	5.2	4.9	24
26									4.4	3.5	4.2	4.7	3.9	4.4	4.2	26
28										2.9	3.6	4.0	3.3	3.8	3.6	28
30											3.0	3.5	2.8	3.3	3.0	30
32												3.0	2.3	2.8	2.6	32
34													1.8	2.3	2.2	34
36													0.7	1.2	1.8	36
38														0.9	0.6	38
40															0.3	40
42																42
44																44
n	10	9	4	6	4	4	4	4	3	3	3	2	2	2	2	n
S2	0	50	0	100	50	0	100	50	0	100	50	0	100	50	100	S2
S3	0	0	25	0	25	50	25	50	75	50	75	100	75	100	100	S3
S4	0	0	25	0	25	50	25	50	75	50	75	100	75	100	100	S4
S5	0	0	25	0	25	50	25	50	75	50	75	100	75	100	100	S5

Unit: t

Load Chart of H

H Load Chart Rear Counterweight 26t, Carbody Counterweight 6t, Track Gauge 3.445m (Crawlers Half Extended), Ground Level 4°																
Radius (m)	Boom length (m)															Radius (m)
	12.2	16.5	18.7	20.9	23	25.2	27.2	29.5	31.8	33.8	36	38.3	40.4	42.5	47	
3	62.5															3
3.5	60.8															3.5
4	55.8	50.0														4
4.5	52.5	48.3														4.5
5	48.3	44.9	25.0	33.3												5
5.5	41.3	39.8	24.9	31.7												5.5
6	38.7	38.3	24.2	29.7	22.9	20.6										6
6.5	31.4	31.1	23.4	28.3	21.9	19.6										6.5
7	30.3	30.0	22.7	27.0	21.2	18.7	21.7									7
7.5	25.0	24.7	22.0	24.5	20.2	18.1	20.7									7.5
8	24.6	24.3	21.3	24.1	19.6	17.3	20.0	18.3	12.6							8
9	20.5	20.2	19.9	20.0	18.1	15.9	18.8	17.1	12.0	15.3	11.2					9
10		17.1	18.7	16.9	16.9	14.9	17.4	16.1	11.3	14.3	10.5	8.3				10
11		14.6	16.3	14.4	15.6	13.7	15.5	15.0	10.5	13.7	10.0	7.9	9.8	3.9		11
12		12.6	14.3	12.5	13.9	12.9	13.5	14.4	9.8	12.8	9.4	7.4	9.4	3.7		12
14			11.0	9.5	10.6	11.3	10.5	10.5	9.3	10.0	8.5	6.8	8.6	3.3	3.3	14
16				7.3	8.2	9.5	8.3	8.3	8.2	8.5	7.6	6.1	7.7	3.0	3.0	16
18					6.5	7.6	6.7	6.6	7.3	6.7	6.9	5.6	7.2	2.8	2.8	18
20						6.3	5.4	5.5	6.0	5.5	6.3	5.0	5.8	2.6	2.6	20
22							4.4	4.5	5.0	4.6	4.9	4.7	4.9	2.3	2.4	22
24								3.7	4.1	3.7	4.1	4.2	4.0	2.0	2.3	24
26									3.5	3.0	3.4	3.9	3.3	1.9	2.1	26
28										2.5	2.9	3.5	2.7	1.6	1.6	28
30											2.4	2.9	2.2	1.4	1.4	30
32												2.5	1.8	1.2	1.2	32
34													1.4	1.0	1.0	34
36															0.8	36
38																38
40																40
42																42
44																44
n	8	7	4	5	3	3	3	3	2	2	2	2	2	1	1	n
S2	0	50	0	100	50	0	100	50	0	100	50	0	100	50	100	S2
S3	0	0	25	0	25	50	25	50	75	50	75	100	75	100	100	S3
S4	0	0	25	0	25	50	25	50	75	50	75	100	75	100	100	S4
S5	0	0	25	0	25	50	25	50	75	50	75	100	75	100	100	S5

Load Chart of H

H Load Chart
Rear Counterweight 26t, Carbody Counterweight 6t, Track Gauge 4.25m (Crawlers Extended),
Ground Level 0~1°

Radius (m)	Boom length (m)															Radius (m)
	12.2	16.5	18.7	20.9	23	25.2	27.2	29.5	31.8	33.8	36	38.3	40.4	42.5	47	
3	80.0	65.0		50.0												3
3.5	75.0	65.0	30.0	50.0	30.0											3.5
4	68.0	62.8	30.0	50.0	30.0	30.0										4
4.5	65.0	60.0	30.0	48.5	30.0	30.0	30.0	28.0								4.5
5	59.0	55.5	30.0	45.7	30.0	30.0	30.0	27.9		26.0						5
5.5	55.1	52.7	30.0	43.6	30.0	30.0	30.0	27.9	21.2	25.0						5.5
6	51.6	50.0	30.0	41.5	30.0	30.0	30.0	27.9	21.2	24.0	20.0		20.0			6
6.5	48.3	45.6	30.0	39.3	30.0	29.2	30.0	27.7	20.8	23.0	19.5		19.0			6.5
7	44.1	41.4	30.0	37.5	30.0	28.2	29.6	26.8	20.2	22.5	19.0	12.1	18.0			7
7.5	39.5	37.9	30.0	35.2	30.0	27.1	28.4	26.0	19.7	21.8	18.5	12.1	17.5	11.0		7.5
8	35.6	34.8	30.0	32.4	30.0	26.2	27.3	24.8	19.2	21.4	18.0	12.1	17.2	11.0		8
9	29.5	29.0	30.0	27.8	29.1	24.4	25.4	23.1	18.3	20.5	16.8	12.1	16.0	11.0	11.7	9
10		24.5	26.6	24.2	25.5	22.8	23.7	21.6	17.3	19.6	15.6	12.0	15.3	11.0	11.5	10
11		21.0	23.1	20.7	22.4	21.6	21.2	20.4	16.0	16.2	14.5	11.4	13.6	10.8	10.7	11
12		18.2	20.3	17.9	19.6	20.4	18.9	19.3	15.2	15.0	13.6	10.8	12.5	10.5	10.6	12
14		14.0	16.0	13.8	15.4	16.7	14.9	16.1	13.8	13.5	12.1	9.9	11.7	10.2	10.2	14
16			13.0	10.8	12.4	13.7	11.9	13.1	12.6	12.4	11.1	9.1	10.0	9.8	9.7	16
18				8.6	10.1	11.4	9.7	10.8	11.7	10.4	10.2	8.0	8.9	8.9	8.1	18
20					8.4	9.7	8	9.1	10	8.7	9.5	7.4	7.7	7.5	7.3	20
22						8.2	6.6	7.7	8.6	7.3	8.1	7.0	7.2	6.4	6.2	22
24							5.4	6.5	7.5	6.1	7.0	6.6	6.6	6.0	5.4	24
26								5.6	6.5	5.2	6.0	5.9	5.6	5.6	5.1	26
28									5.7	4.4	5.2	5.1	4.8	5.4	4.9	28
30										3.7	4.5	4.4	4.1	4.8	4.4	30
32											3.9	3.8	3.5	4.2	3.8	32
34												3.2	3.0	3.6	3.3	34
36													2.5	3.2	2.8	36
38														2.8	2.4	38
40															2.1	40
42															1.7	42
44															1.4	44
n	10	9	4	7	4	4	4	4	3	4	3	2	3	2	2	n
S2	0	50	0	100	50	0	100	50	0	100	50	0	100	50	100	S2
S3	0	0	25	0	25	50	25	50	75	50	75	100	75	100	100	S3
S4	0	0	25	0	25	50	25	50	75	50	75	100	75	100	100	S4
S5	0	0	25	0	25	50	25	50	75	50	75	100	75	100	100	S5

Unit: t

Load Chart of H

H Load Chart Rear Counterweight 26t, Carbody Counterweight 6t, Track Gauge 4.25m (Crawlers Extended), Ground Level 4°																
Radius (m)	Boom length (m)															Radius (m)
	12.2	16.5	18.7	20.9	23	25.2	27.2	29.5	31.8	33.8	36	38.3	40.4	42.5	47	
3	62.5	54.2														3
3.5	60.8	52.5														3.5
4	58.5	50.0	30.0	35.8												4
4.5	58.5	48.3	30.0	35.5	28.6	23.4		23.0								4.5
5	55.4	44.9	30.0	33.3	28.6	23.4	25.0	22.5		19.8						5
5.5	50.0	42.1	30.0	31.7	28.6	23.4	24.7	21.9		19.2						5.5
6	44.6	39.6	30.0	29.7	28.6	23.4	23.5	20.8	14.8	18.6	15.0		15.0			6
6.5	40.1	35.5	30.0	28.3	28.6	23.4	22.4	20.2	14.1	17.9	13.2		14.3			6.5
7	36.3	33.0	30.0	27.1	28.6	23.4	21.7	19.5	13.6	17.4	12.8		13.5			7
7.5	33.1	31.0	30.0	26.9	27.5	23.4	20.7	18.9	13.0	16.8	12.3		11.6	8.1		7.5
8	30.4	27.6	28.9	25.1	25.8	23.4	20.0	18.3	12.6	16.3	11.9		11.4	8.1		8
9	26.2	23.5	25.0	21.9	22.9	23.3	18.8	17.1	12.5	15.3	11.2		10.8	8.1	8.1	9
10		20.4	21.9	18.9	20.1	21.0	18.4	16.1	12.5	14.3	10.5	8.3	10.4	8.1	7.7	10
11		17.9	19.4	16.6	17.8	18.7	16.6	15.7	12.5	13.7	10.0	7.9	9.8	7.7	7.3	11
12		15.8	17.3	14.6	15.8	16.8	14.7	15.6	12.5	12.8	9.6	7.4	9.4	7.3	7.1	12
14		12.9	14.2	11.6	12.8	13.8	11.9	12.8	12.5	11.5	9.6	6.8	8.6	6.6	6.5	14
16			12.0	9.4	10.6	11.6	9.7	10.6	11.4	9.9	9.6	6.6	7.7	6.0	6.0	16
18				7.7	8.9	9.9	8.1	9.0	9.8	8.3	9.0	6.6	7.2	5.5	5.5	18
20					7.6	8.6	6.7	7.7	8.5	7.0	7.7	6.6	6.8	5.4	5.2	20
22						7.5	5.7	6.6	7.4	5.9	6.7	6.4	6.1	5.4	4.8	22
24							4.8	5.7	6.5	5.1	5.8	5.6	5.2	5.4	4.5	24
26								5.0	5.8	4.3	5.1	4.8	4.5	5.1	4.5	26
28									5.2	3.7	4.4	4.2	3.9	4.5	4.0	28
30										3.2	3.9	3.7	3.4	3.9	3.5	30
32											3.4	3.2	2.9	3.5	3.0	32
34												2.8	2.5	3.1	2.6	34
36													2.1	2.7	2.2	36
38														2.4	1.9	38
40															1.6	40
42															1.4	42
44															1.2	44
n	8	7	4	5	4	3	4	3	2	3	2	2	2	2	2	n
S2	0	50	0	100	50	0	100	50	0	100	50	0	100	50	100	S2
S3	0	0	25	0	25	50	25	50	75	50	75	100	75	100	100	S3
S4	0	0	25	0	25	50	25	50	75	50	75	100	75	100	100	S4
S5	0	0	25	0	25	50	25	50	75	50	75	100	75	100	100	S5

Load Chart of H

H Load Chart
Rear Counterweight 26t, Carbody Counterweight 0t, Track Gauge 2.64m (Crawlers Retracted),
Ground Level 0~1°

Radius (m)	Boom length (m)															Radius (m)
	12.2	16.5	18.7	20.9	23	25.2	27.2	29.5	31.8	33.8	36	38.3	40.4	42.5	47	
3	74.6	65.0														3
3.5	58.0	51.2														3.5
4	52.9	47.4	30.0	43.0												4
4.5	41.5	38.2	30.0	35.0												4.5
5	38.4	36.7	30.0	33.8	30.0	27.0										5
5.5	30.6	29.7	30.0	27.8	28.6	26.0										5.5
6	29.0	28.7	29.0	27.4	28.4	25.0	26.3	25.0								6
6.5	23.6	23.3	25.1	22.6	24.2	24.4	22.5	23.2								6.5
7	22.9	22.6	24.5	22.4	23.9	24.0	22.2	22.9	19.0	21.4						7
7.5	18.9	18.6	20.3	18.5	19.8	21.2	18.7	19.4	18.0	18.1						7.5
8	18.7	18.4	20.2	18.2	19.7	20.9	19.0	19.8	17.0	18.5	18.0					8
9	15.5	15.3	17.0	15.1	16.5	17.7	16.2	17.2	16.0	16.2	16.8		15.7			9
10		12.8	14.5	12.7	14.1	15.2	13.7	14.7	15.0	14.3	14.9	11.0	14.0	11.0		10
11		10.9	12.6	10.7	12.1	13.2	11.8	12.8	13.6	12.4	13.2	10.5	12.5	10.8	11.0	11
12		9.4	11.0	9.2	10.5	11.6	10.2	11.2	12.0	10.9	11.6	10.2	11.3	10.5	11.0	12
14			8.6	6.8	8.1	9.2	7.8	8.8	9.6	8.4	9.2	9.6	8.9	9.4	9.1	14
16				5.1	6.4	7.4	6.1	7.0	7.8	6.7	7.4	8.0	7.1	7.7	7.4	16
18					5.0	6.1	4.7	5.7	6.4	5.4	6.0	6.7	5.8	6.3	6.1	18
20						5.0	3.7	4.6	5.4	4.3	5.0	5.6	4.7	5.3	5.0	20
22							2.9	3.8	4.5	3.5	4.1	4.7	3.9	4.4	4.1	22
24								3.1	3.8	2.8	3.4	4.0	3.2	3.7	3.4	24
26									3.2	2.2	2.8	3.4	2.6	3.1	2.8	26
28										1.7	2.3	2.9	2.1	2.6	2.3	28
30											1.9	2.5	1.6	2.2	1.9	30
32												2.1	1.3	1.8	1.5	32
34													0.9	1.5	1.2	34
36															0.9	36
38																38
40																40
42																42
44																44
n	10	9	4	6	4	4	4	4	3	3	3	2	2	2	2	n
S2	0	50	0	100	50	0	100	50	0	100	50	0	100	50	100	S2
S3	0	0	25	0	25	50	25	50	75	50	75	100	75	100	100	S3
S4	0	0	25	0	25	50	25	50	75	50	75	100	75	100	100	S4
S5	0	0	25	0	25	50	25	50	75	50	75	100	75	100	100	S5

Unit: t

Load Chart of H

H Load Chart Rear Counterweight 26t, Carbody Counterweight 0t, Track Gauge 2.64m (Crawlers Retracted), Ground Level 4°																
Radius (m)	Boom length (m)															Radius (m)
	12.2	16.5	18.7	20.9	23	25.2	27.2	29.5	31.8	33.8	36	38.3	40.4	42.5	47	
3	62.5															3
3.5	58.0															3.5
4	52.9	43.0														4
4.5	41.3	38.0														4.5
5	38.0	36.7	25.0	28.7												5
5.5	30.3	29.6	24.9	28.1												5.5
6	28.7	28.4	24.2	27.4	22.9	20.6										6
6.5	23.4	23.1	23.4	22.6	21.9	19.6										6.5
7	22.7	22.4	22.7	22.2	21.2	18.7	19.0									7
7.5	18.7	18.5	20.1	18.3	19.6	18.1	19.0									7.5
8	18.5	18.2	20.0	18.0	19.5	17.3	19.0	17.4	12.6							8
9	15.3	15.1	16.8	14.9	16.3	15.9	16.0	17.0	12.0	13.7	11.2					9
10		12.7	14.4	12.5	13.9	14.9	13.6	14.6	11.3	13.0	10.5	8.3				10
11		10.8	12.4	10.6	12.0	13.1	11.7	12.6	10.5	12.3	10.0	7.9	9.8	3.9		11
12		9.2	10.9	9.1	10.4	11.5	10.1	11.1	9.8	10.7	9.4	7.4	9.4	3.7		12
14			8.5	6.7	8.0	9.1	7.7	8.7	9.3	8.3	8.5	6.8	8.6	3.3	3.3	14
16				5.0	6.3	7.3	6.0	6.9	7.7	6.6	7.3	6.1	7.0	3.0	3.0	16
18					5.0	6.0	4.7	5.6	6.4	5.3	6.0	5.6	5.7	2.8	2.8	18
20						4.9	3.6	4.5	5.3	4.2	4.9	5.0	4.6	2.6	2.6	20
22							2.8	3.7	4.5	3.4	4.1	4.7	3.8	2.3	2.4	22
24								3.0	3.8	2.7	3.4	4.0	3.1	2.0	2.3	24
26									3.2	2.1	2.8	3.4	2.5	1.9	2.1	26
28										1.6	2.3	2.9	2.0	1.6	1.6	28
30											1.9	2.5	1.6	1.4	1.4	30
32												2.1	1.2	1.2	1.2	32
34													0.9	1.0	1.0	34
36															0.8	36
38																38
40																40
42																42
44																44
n	8	6	4	4	3	3	3	3	2	2	2	2	2	1	1	n
S2	0	50	0	100	50	0	100	50	0	100	50	0	100	50	100	S2
S3	0	0	25	0	25	50	25	50	75	50	75	100	75	100	100	S3
S4	0	0	25	0	25	50	25	50	75	50	75	100	75	100	100	S4
S5	0	0	25	0	25	50	25	50	75	50	75	100	75	100	100	S5

Load Chart of H

H Load Chart
Rear Counterweight 26t, Carbody Counterweight 0t, Track Gauge 3.445m (Crawlers Half Extended),
Ground Level 0~1°

Radius (m)	Boom length (m)															Radius (m)
	12.2	16.5	18.7	20.9	23	25.2	27.2	29.5	31.8	33.8	36	38.3	40.4	42.5	47	
3	80.0	65.0														3
3.5	75.0	63.0														3.5
4	68.0	61.0	30.0	43.0												4
4.5	54.4	49.3	30.0	42.5												4.5
5	50.3	46.9	30.0	42.0	30.0	27.0										5
5.5	39.8	38.1	29.0	35.4	30.0	26.0										5.5
6	37.2	36.9	29.0	34.7	29.0	25.0	30.0	25.0								6
6.5	30.1	29.9	29.0	28.8	29.0	24.5	28.0	24.5								6.5
7	29.1	28.8	29.0	28.6	29.0	24.0	27.7	24.0	19.0	22.0						7
7.5	24.0	23.7	25.5	23.5	24.7	23.1	24.0	23.5	18.0	21.0						7.5
8	23.6	23.3	25.2	23.1	24.7	22.8	23.7	23.0	17.0	20.0	18.0					8
9	19.6	19.3	21.2	19.1	20.7	21.5	20.3	21.4	16.0	18.8	16.8		15.8			9
10		16.3	18.1	16.1	17.6	18.8	17.2	18.3	15.0	17.5	15.6	11.0	14.8	11.0		10
11		13.9	15.7	13.7	15.2	16.3	14.8	15.9	14.0	15.5	14.5	10.5	13.6	10.8	11.0	11
12		12.0	13.7	11.8	13.3	14.4	12.9	13.9	13.2	13.6	13.6	10.2	12.5	10.5	11.0	12
14			10.8	8.9	10.3	11.4	10.0	11.0	11.6	10.6	11.4	9.6	11.0	10.2	10.0	14
16				6.9	8.2	9.3	7.9	8.9	9.7	8.5	9.3	8.8	9.0	9.5	9.0	16
18					6.6	7.7	6.3	7.3	8.1	6.9	7.6	8.0	7.4	7.9	7.7	18
20						6.4	5.1	6.0	6.8	5.7	6.4	7.0	6.1	6.7	6.4	20
22							4.1	5.0	5.8	4.7	5.4	6.0	5.1	5.6	5.4	22
24								4.2	4.9	3.9	4.6	5.2	4.3	4.8	4.6	24
26									4.2	3.2	3.9	4.5	3.6	4.1	3.9	26
28										2.6	3.3	3.9	3.0	3.5	3.3	28
30											2.8	3.4	2.5	3.0	2.8	30
32												2.9	2.1	2.6	2.3	32
34													1.7	2.2	2.0	34
36														0.7	1.6	36
38															0.4	38
40																40
42																42
44																44
n	10	9	4	6	4	4	4	4	3	3	3	2	2	2	2	n
S2	0	50	0	100	50	0	100	50	0	100	50	0	100	50	100	S2
S3	0	0	25	0	25	50	25	50	75	50	75	100	75	100	100	S3
S4	0	0	25	0	25	50	25	50	75	50	75	100	75	100	100	S4
S5	0	0	25	0	25	50	25	50	75	50	75	100	75	100	100	S5

Unit: t

Load Chart of H

H Load Chart																
Rear Counterweight 26t, Carbody Counterweight 0t, Track Gauge 3.445m (Crawlers Half Extended), Ground Level 4°																
Radius (m)	Boom length (m)															Radius (m)
	12.2	16.5	18.7	20.9	23	25.2	27.2	29.5	31.8	33.8	36	38.3	40.4	42.5	47	
3	62.5															3
3.5	60.8															3.5
4	55.8	50.0														4
4.5	52.5	48.3														4.5
5	48.3	44.9	25.0	33.3												5
5.5	39.4	37.9	24.9	31.7												5.5
6	36.9	36.5	24.2	29.7	22.9	20.6										6
6.5	29.9	29.6	23.4	28.3	21.9	19.6										6.5
7	28.9	28.6	22.7	27.0	21.2	18.7	21.7									7
7.5	23.8	23.5	22.0	23.3	20.2	18.1	20.7									7.5
8	23.4	23.1	21.3	22.9	19.6	17.3	20.0	18.3	12.6							8
9	19.4	19.2	19.9	19.0	18.1	15.9	18.8	17.1	12.0	15.3	11.2					9
10		16.2	17.9	16.0	16.9	14.9	17.1	16.1	11.3	14.3	10.5	8.3				10
11		13.8	15.5	13.6	15.0	13.7	14.7	15.0	10.5	13.7	10.0	7.9	9.8	3.9		11
12		11.9	13.6	11.7	13.1	12.9	12.8	13.8	9.8	12.8	9.4	7.4	9.4	3.7		12
14			10.7	8.9	10.2	11.3	9.9	10.5	9.3	10.0	8.5	6.8	8.6	3.3	3.3	14
16				6.8	8.1	9.2	7.8	8.3	8.2	8.4	7.6	6.1	7.7	3.0	3.0	16
18					6.5	7.6	6.2	6.6	7.3	6.7	6.9	5.6	7.2	2.8	2.8	18
20						6.3	5.0	5.5	6.0	5.5	6.3	5.0	5.8	2.6	2.6	20
22							4.0	4.5	5.0	4.6	4.9	4.7	4.9	2.3	2.4	22
24								3.7	4.1	3.7	4.1	4.2	4.0	2.0	2.3	24
26									3.5	3.0	3.4	3.9	3.3	1.9	2.1	26
28										2.5	2.9	3.5	2.7	1.6	1.6	28
30											2.4	2.9	2.2	1.4	1.4	30
32												2.5	1.8	1.2	1.2	32
34													1.4	1.0	1.0	34
36															0.8	36
38																38
40																40
42																42
44																44
n	8	7	4	5	3	3	3	3	2	2	2	2	2	1	1	n
S2	0	50	0	100	50	0	100	50	0	100	50	0	100	50	100	S2
S3	0	0	25	0	25	50	25	50	75	50	75	100	75	100	100	S3
S4	0	0	25	0	25	50	25	50	75	50	75	100	75	100	100	S4
S5	0	0	25	0	25	50	25	50	75	50	75	100	75	100	100	S5

Load Chart of H

H Load Chart Rear Counterweight 26t, Carbody Counterweight 0t, Track Gauge 4.25m (Crawlers Extended), Ground Level 0~1°																
Radius (m)	Boom length (m)															Radius (m)
	12.2	16.5	18.7	20.9	23	25.2	27.2	29.5	31.8	33.8	36	38.3	40.4	42.5	47	
3	80.0	65.0														3
3.5	75.0	65.0		50.0												3.5
4	68.0	62.8	30.0	50.0												4
4.5	65.0	60.0	30.0	48.5	30.0		30.0									4.5
5	59.0	55.5	30.0	45.7	30.0	30.0	30.0									5
5.5	55.1	52.7	30.0	43.6	30.0	30.0	30.0	27.9								5.5
6	51.6	48.2	30.0	41.5	30.0	30.0	30.0	27.9		22.0						6
6.5	47.6	43.4	30.0	39.3	30.0	29.2	30.0	27.7	20.8	22.0						6.5
7	42.1	39.4	30.0	36.5	30.0	28.2	29.6	26.8	20.2	22.0		12.1				7
7.5	37.6	36.0	30.0	33.4	30.0	27.1	28.4	26.0	19.7	21.0		12.1	15.8	11.0		7.5
8	33.9	33.1	30.0	30.7	30.0	26.2	27.3	24.8	19.2	20.0	18.0	12.1	15.8	11.0		8
9	28.0	27.5	29.8	26.3	27.6	24.4	25.4	23.1	18.3	18.8	16.8	12.1	15.8	11.0	11.0	9
10		23.2	25.4	22.9	24.2	22.8	22.6	21.6	17.3	17.5	15.6	12.0	14.8	11.0	11.0	10
11		19.8	22.0	19.6	21.3	21.6	20.0	20.4	16.0	16.2	14.5	11.4	13.6	10.8	11.0	11
12		17.2	19.2	16.9	18.6	20.0	17.8	18.8	15.2	15.0	13.6	10.8	12.5	10.5	11.0	12
14		13.1	15.2	12.9	14.5	15.9	14.1	15.3	13.8	13.5	12.1	9.9	11.0	10.2	10.0	14
16			12.3	10.1	11.7	13.0	11.2	12.4	12.6	11.9	11.1	9.1	10.0	9.8	9.0	16
18				8.0	9.5	10.8	9.1	10.2	11.2	9.8	10.2	8.0	8.9	8.9	8.1	18
20					7.8	9.1	7.4	8.5	9.5	8.1	8.9	7.4	7.7	7.5	7.3	20
22						7.7	6.1	7.2	8.1	6.8	7.6	7.0	7.2	6.4	6.2	22
24							5.0	6.1	7.0	5.7	6.5	6.3	6.1	6.0	5.4	24
26								5.2	6.1	4.7	5.6	5.4	5.2	5.6	5.1	26
28									5.3	4.0	4.8	4.7	4.4	5.1	4.7	28
30										3.3	4.1	4.0	3.8	4.4	4.1	30
32											3.6	3.4	3.2	3.8	3.5	32
34												2.9	2.7	3.3	3.0	34
36													2.2	2.9	2.5	36
38														2.5	2.1	38
40															1.8	40
42															1.5	42
44															1.2	44
n	10	9	4	7	4	4	4	4	3	3	3	2	2	2	2	n
S2	0	50	0	100	50	0	100	50	0	100	50	0	100	50	100	S2
S3	0	0	25	0	25	50	25	50	75	50	75	100	75	100	100	S3
S4	0	0	25	0	25	50	25	50	75	50	75	100	75	100	100	S4
S5	0	0	25	0	25	50	25	50	75	50	75	100	75	100	100	S5

Unit: t

Load Chart of H

H Load Chart Rear Counterweight 26t, Carbody Counterweight 0t, Track Gauge 4.25m (Crawlers Extended), Ground Level 4°																
Radius (m)	Boom length (m)															Radius (m)
	12.2	16.5	18.7	20.9	23	25.2	27.2	29.5	31.8	33.8	36	38.3	40.4	42.5	47	
3	62.5															3
3.5	60.8															3.5
4	55.8	50.0														4
4.5	52.5	48.3														4.5
5	48.3	44.9	30.0	33.3												5
5.5	47.6	42.1	30.0	31.7												5.5
6	42.5	39.6	30.0	29.7	28.6	24.1										6
6.5	38.2	35.0	30.0	28.3	28.6	24.1										6.5
7	34.6	33.0	30.0	27.0	28.0	24.1	21.7									7
7.5	31.5	29.3	29.7	25.7	26.1	24.1	20.7									7.5
8	28.9	26.5	27.5	24.5	24.5	24.1	20.0	18.3	12.6					5.5		8
9	24.8	22.3	23.7	21.8	21.7	22.4	18.8	17.1	12.6	15.3	11.2			5.5	4.5	9
10		19.3	20.8	18.3	19.1	20.0	17.4	16.1	12.6	14.3	10.5	8.3		5.5	4.5	10
11		16.9	18.4	15.8	16.8	17.8	16.2	15.7	12.6	13.7	10.0	7.9	9.8	5.5	4.5	11
12		14.9	16.4	13.7	15.0	16.0	14.5	14.8	12.6	12.8	9.7	7.4	9.4	5.5	4.5	12
14		12.1	13.4	10.8	12.1	13.1	11.4	12.0	12.6	11.2	9.7	6.8	8.6	5.5	4.5	14
16			11.3	8.7	9.9	11.0	9.1	10.0	10.8	9.2	9.7	6.6	7.7	5.5	4.5	16
18				7.1	8.3	9.3	7.5	8.4	9.2	7.7	8.4	6.6	7.2	5.5	4.5	18
20					7.1	8.1	6.2	7.2	8.0	6.5	7.2	6.6	6.6	5.5	4.5	20
22						7.1	5.2	6.1	6.9	5.5	6.2	6.0	5.6	5.5	4.5	22
24							4.4	5.3	6.1	4.6	5.4	5.1	4.8	5.4	4.5	24
26								4.6	5.4	3.9	4.7	4.4	4.1	4.7	4.2	26
28									4.8	3.4	4.1	3.8	3.5	4.1	3.7	28
30										2.9	3.6	3.3	3.0	3.6	3.2	30
32											3.1	2.9	2.6	3.2	2.7	32
34												2.5	2.2	2.8	2.3	34
36													1.9	2.4	2.0	36
38														2.1	1.7	38
40															1.4	40
42															1.2	42
44															1.0	44
n	8	7	4	5	4	4	3	3	2	2	2	2	2	1	1	n
S2	0	50	0	100	50	0	100	50	0	100	50	0	100	50	100	S2
S3	0	0	25	0	25	50	25	50	75	50	75	100	75	100	100	S3
S4	0	0	25	0	25	50	25	50	75	50	75	100	75	100	100	S4
S5	0	0	25	0	25	50	25	50	75	50	75	100	75	100	100	S5

Load Chart of H

H Load Chart
Rear Counterweight 0t, Carbody Counterweight 6t, Track Gauge 2.64m (Crawlers Retracted),
Ground Level 0~1°

Radius (m)	Boom length (m)															Radius (m)
	12.2	16.5	18.7	20.9	23	25.2	27.2	29.5	31.8	33.8	36	38.3	40.4	42.5	47	
3	33.1	28.0	29.3	24.2												3
3.5	27.0	23.0	24.6	20.1	21.3											3.5
4	22.5	19.3	21.1	16.9	18.3	19.3										4
4.5	19.1	16.4	18.3	14.5	15.9	17.0	14.0									4.5
5	16.4	14.1	16.0	12.4	13.9	15.1	12.3	13.2								5
5.5	14.3	12.2	14.2	10.7	12.3	13.5	10.8	11.8	12.6							5.5
6	12.5	10.6	12.6	9.3	10.9	12.1	9.5	10.6	11.5	9.4						6
6.5	11.0	9.3	11.3	8.1	9.7	10.9	8.4	9.5	10.4	8.4	9.2					6.5
7	9.7	8.1	10.1	7.1	8.6	9.9	7.5	8.6	9.5	7.5	8.4	7.9	7.4			7
7.5	8.5	7.1	9.1	6.2	7.7	9.0	6.7	7.8	8.7	6.8	7.6	7.2	6.7	7.3		7.5
8	7.4	6.2	8.3	5.3	6.9	8.2	5.9	7.1	8.0	6.1	7.0	6.6	6.1	6.7		8
9	5.6	4.8	6.8	4.0	5.6	6.9	4.7	5.8	6.8	5.0	5.8	5.5	5.0	5.7	5.0	9
10		3.6	5.6	2.9	4.5	5.8	3.7	4.8	5.8	4.0	4.9	4.8	4.2	4.8	4.2	10
11		2.7	4.7	2.0	3.6	4.9	2.8	4.0	4.9	3.2	4.1	4.1	3.4	4.1	3.5	11
12		1.8	3.8	1.3	2.9	4.2	2.1	3.3	4.2	2.6	3.4	3.5	2.8	3.5	2.9	12
14		0.5	2.4		1.7	3.0	1.0	2.1	3.1	1.5	2.4	2.6	1.8	2.5	1.9	14
16			1.4		0.8	2.1		1.3	2.2	0.7	1.5	1.8	1.0	1.7	1.2	16
18						1.3		0.6	1.6		0.9	1.2	0.4	1.1	0.6	18
20						0.7			1.0		0.3	0.7		0.5		20
22									0.6							22
n	5	4	4	4	3	3	2	2	2	2	2	1	1	1	1	n
S2	0	50	0	100	50	0	100	50	0	100	50	0	100	50	100	S2
S3	0	0	25	0	25	50	25	50	75	50	75	100	75	100	100	S3
S4	0	0	25	0	25	50	25	50	75	50	75	100	75	100	100	S4
S5	0	0	25	0	25	50	25	50	75	50	75	100	75	100	100	S5

Unit: t

Load Chart of H

H Load Chart Rear Counterweight 0t, Carbody Counterweight 6t, Track Gauge 2.64m (Crawlers Retracted), Ground Level 4°																
Radius (m)	Boom length (m)															Radius (m)
	12.2	16.5	18.7	20.9	23	25.2	27.2	29.5	31.8	33.8	36	38.3	40.4	42.5	47	
3	28.7		17.5	13.1												3
3.5	21.8		15.3	11.3	12.2											3.5
4	19.3	16.7	14.6	9.7	10.8	11.6										4
4.5	14.9	13.1	14.1	8.5	9.6	10.5	7.8									4.5
5	13.4	12.0	13.8	13.8	9.3	10.4	6.9	7.7								5
5.5	10.3	9.5	11.2	8.4	9.3	10.4	6.4	7.0	7.7							5.5
6	9.4	8.9	10.8	7.8	9.3	10.4	6.4	6.3	7.1	5.1						6
6.5	8.4	7.0	8.7	6.2	7.6	8.6	6.4	6.0	6.8	4.6	5.3					6.5
7	7.4	6.4	8.3	5.8	7.3	8.5	6.4	6.0	6.8	4.5	4.9	4.8	3.5			7
7.5	6.5	5.0	6.7	4.6	6.0	7.1	5.2	6.0	6.8	4.5	4.9	4.8	3.5	3.8		7.5
8	5.7	4.6	6.4	4.3	5.8	7.0	5.0	6.0	6.8	4.3	4.9	4.8	3.1	3.7		8
9	4.5	3.3	5.0	3.1	4.5	5.7	3.9	4.9	5.8	4.2	4.9	4.8	2.8	3.4	1.7	9
10		2.3	3.9	2.1	3.5	4.6	3.0	4.0	4.9	3.3	4.1	4.8	2.8	3.4	1.7	10
11		1.6	3.1	1.2	2.6	3.7	2.2	3.3	4.1	2.6	3.4	4.1	2.8	3.4	1.5	11
12		1.0	2.4		1.9	3.0	1.6	2.6	3.4	2.0	2.8	3.5	2.3	2.9	1.5	12
14			1.3		0.9	1.9		1.5	2.3	1.1	1.9	2.5	1.4	2.0	1.5	14
16			1.0			1.1		0.7	1.5		1.1	1.7	0.7	1.3	0.9	16
18						0.7			0.9			1.1		0.7		18
20						0.3			0.4			0.7				20
n	4	3	3	2	2	2	1	1	1	1	1	1	1	1	1	n
S2	0	50	0	100	50	0	100	50	0	100	50	0	100	50	100	S2
S3	0	0	25	0	25	50	25	50	75	50	75	100	75	100	100	S3
S4	0	0	25	0	25	50	25	50	75	50	75	100	75	100	100	S4
S5	0	0	25	0	25	50	25	50	75	50	75	100	75	100	100	S5

Load Chart of H

H Load Chart Rear Counterweight 0t, Carbody Counterweight 6t, Track Gauge 3.445m (Crawlers Half Extended), Ground Level 0~1°																
Radius (m)	Boom length (m)															Radius (m)
	12.2	16.5	18.7	20.9	23	25.2	27.2	29.5	31.8	33.8	36	38.3	40.4	42.5	47	
3	49.6	41.6	30.0	35.8												3
3.5	39.7	33.9	30.0	29.5	30.0											3.5
4	32.8	28.3	29.8	24.9	26.1	26.9										4
4.5	27.7	24.0	25.7	21.3	22.6	23.6	20.1									4.5
5	23.8	20.7	22.5	18.4	19.8	20.9	17.7	18.6								5
5.5	20.7	18.0	19.9	16.0	17.5	18.7	15.7	16.6	17.4							5.5
6	18.1	15.8	17.7	14.1	15.6	16.8	13.9	15.0	15.8	13.5						6
6.5	16.0	13.9	15.9	12.4	14.0	15.2	12.5	13.5	14.4	12.2	12.9					6.5
7	14.2	12.4	14.4	11.0	12.6	13.8	11.2	12.3	13.2	11.0	11.8	11.3	10.7			7
7.5	12.4	11.0	13.0	9.8	11.4	12.7	10.1	11.2	12.1	10.0	10.8	10.4	9.8	10.2		7.5
8	10.9	9.8	11.9	8.7	10.3	11.6	9.1	10.3	11.2	9.1	10.0	9.5	9.0	9.6		8
9	8.6	7.9	9.9	6.9	8.6	9.9	7.5	8.6	9.6	7.6	8.5	8.1	7.6	8.2	7.2	9
10		6.3	8.4	5.5	7.1	8.4	6.2	7.3	8.3	6.4	7.3	7.1	6.5	7.1	6.4	10
11		4.9	7.0	4.4	6.0	7.3	5.1	6.2	7.2	5.4	6.3	6.2	5.5	6.2	5.5	11
12		3.8	5.8	3.4	5.0	6.3	4.2	5.3	6.3	4.5	5.4	5.4	4.7	5.4	4.7	12
14		2.1	4.1	1.9	3.4	4.7	2.7	3.9	4.9	3.2	4.1	4.1	3.4	4.1	3.5	14
16			2.8	0.7	2.2	3.5	1.6	2.8	3.8	2.1	3.0	3.1	2.4	3.1	2.6	16
18					1.3	2.5	0.8	1.9	2.9	1.3	2.2	2.3	1.6	2.3	1.8	18
20					0.5	1.8		1.2	2.1	0.6	1.5	1.7	1.0	1.7	1.2	20
22						1.2		0.6	1.5		1.0	1.2	0.5	1.2	0.7	22
24									1.0		0.5	0.8		0.7	0.3	24
26									0.6					0.3		26
28									0.3							28
n	7	6	4	5	4	4	3	3	3	2	2	2	2	2	1	n
S2	0	50	0	100	50	0	100	50	0	100	50	0	100	50	100	S2
S3	0	0	25	0	25	50	25	50	75	50	75	100	75	100	100	S3
S4	0	0	25	0	25	50	25	50	75	50	75	100	75	100	100	S4
S5	0	0	25	0	25	50	25	50	75	50	75	100	75	100	100	S5

Unit: t

Load Chart of H

H Load Chart Rear Counterweight 0t, Carbody Counterweight 6t, Track Gauge 3.445m (Crawlers Half Extended), Ground Level 4°																
Radius (m)	Boom length (m)															Radius (m)
	12.2	16.5	18.7	20.9	23	25.2	27.2	29.5	31.8	33.8	36	38.3	40.4	42.5	47	
3	44.1		24.9	19.6												3
3.5	33.2		21.8	17.0	17.7											3.5
4	28.9	25.1	19.9	16.3	15.8	16.4										4
4.5	22.4	19.7	19.9	16.3	14.1	14.9	11.7									4.5
5	20.3	18.2	19.9	16.3	13.8	14.9	10.5	11.3								5
5.5	15.8	14.6	16.1	13.1	13.8	14.9	9.9	10.3	10.9							5.5
6	14.3	13.8	15.6	12.4	13.8	14.9	9.9	9.4	10.1	7.9						6
6.5	12.5	10.9	12.6	10.0	11.3	12.3	9.9	9.0	9.9	7.2	7.9					6.5
7	11.1	10.2	12.2	9.6	11.1	12.2	9.9	9.0	9.9	6.7	7.5		6.1			7
7.5	9.9	8.1	9.9	7.8	9.1	10.5	8.1	9.0	9.9	6.7	7.5	7.1	5.7	5.4		7.5
8	8.8	7.7	9.6	7.5	9.0	10.2	8.0	9.0	9.9	6.7	7.5	7.1	5.2	5.4		8
9	7.2	5.9	7.7	5.7	7.2	8.4	6.5	7.6	8.4	6.7	7.5	7.1	4.8	5.0	4.2	9
10		4.6	6.2	4.3	5.7	6.9	5.3	6.4	7.3	5.6	6.4	7.1	4.8	4.4	3.6	10
11		3.6	5.4	3.2	4.6	5.7	4.3	5.3	6.2	4.7	5.5	6.2	4.8	3.9	3.1	11
12		2.8	4.5	2.3	3.7	4.8	3.4	4.4	5.2	3.9	4.7	5.4	4.1	3.9	3.1	12
14		1.6	3.2	1.0	2.3	3.5	2.0	3.0	3.8	2.6	3.4	4.0	2.9	3.7	3.1	14
16			2.3		1.4	2.6	1.0	2.0	2.8	1.7	2.4	3.0	2.0	3.3	2.2	16
18					0.7	1.8		1.2	2.0	0.9	1.6	2.2	1.3	2.6	1.5	18
20						1.3		0.6	1.4		1.0	1.6	0.7	1.9	1.0	20
22						0.8			1.0		0.3	1.2		1.3		22
24									0.6			0.8		0.8		24
26									0.3							26
n	6	4	4	3	3	3	2	2	2	1	1	1	1	1	1	n
S2	0	50	0	100	50	0	100	50	0	100	50	0	100	50	100	S2
S3	0	0	25	0	25	50	25	50	75	50	75	100	75	100	100	S3
S4	0	0	25	0	25	50	25	50	75	50	75	100	75	100	100	S4
S5	0	0	25	0	25	50	25	50	75	50	75	100	75	100	100	S5

Load Chart of H

H Load Chart
Rear Counterweight 0t, Carbody Counterweight 6t, Track Gauge 4.25m (Crawlers Extended),
Ground Level 0~1°

Radius (m)	Boom length (m)															Radius (m)	
	12.2	16.5	18.7	20.9	23	25.2	27.2	29.5	31.8	33.8	36	38.3	40.4	42.5	47		
3	73.2	60.2	30.0	50.0												3	
3.5	56.7	47.9	30.0	41.5	30.0											3.5	
4	46.0	39.5	30.0	34.6	30.0	30.0										4	
4.5	38.3	33.2	30.0	29.5	30.0	30.0	27.4									4.5	
5	32.7	28.5	30.0	25.4	26.8	27.7	24.0	24.8								5	
5.5	28.3	24.8	26.6	22.2	23.6	24.7	21.3	22.1	21.2							5.5	
6	24.8	21.7	23.7	19.6	21.0	22.2	19.0	19.9	20.6	18.1	17.0					6	
6.5	21.9	19.3	21.2	17.3	18.9	20.0	17.0	18.0	18.8	16.4	15.7					6.5	
7	19.3	17.2	19.2	15.5	17.0	18.2	15.4	16.4	17.2	14.9	15.6	12.1	12.9			7	
7.5	17.0	15.4	17.4	13.9	15.4	16.7	13.9	15.0	15.9	13.6	14.4	12.1	12.6	10.2		7.5	
8	15.0	13.8	15.9	12.5	14.1	15.3	12.7	13.8	14.7	12.5	13.3	12.1	12.1	10.2		8	
9	11.9	11.3	13.4	10.2	11.8	13.1	10.6	11.7	12.6	10.6	11.4	10.9	10.4	10.2	9.1	9	
10		9.1	11.3	8.3	10.0	11.3	8.9	10.0	11.0	9.0	9.9	9.9	8.9	9.6	7.9	10	
11		7.3	9.5	6.9	8.5	9.8	7.5	8.7	9.6	7.7	8.6	8.7	7.7	8.4	7.3	11	
12		5.9	8.0	5.7	7.3	8.6	6.4	7.5	8.5	6.7	7.5	7.8	6.7	7.4	6.7	12	
14		3.8	5.8	3.6	5.2	6.5	4.6	5.7	6.7	5.0	5.9	6.0	5.1	5.8	5.2	14	
16			4.3	2.1	3.7	5.0	3.2	4.4	5.4	3.7	4.6	4.7	3.9	4.6	4.0	16	
18				1.0	2.5	3.8	2.1	3.2	4.2	2.7	3.6	3.7	3.0	3.7	3.1	18	
20					1.6	2.9	1.2	2.3	3.3	1.9	2.7	2.3	2.2	2.9	2.4	20	
22						2.2	0.5	1.6	2.5	1.2	2.0	2.3	1.5	2.3	1.8	22	
24								1.0	1.9	0.6	1.4	1.8	1.0	1.7	1.2	24	
26									0.5	1.4		0.9	1.4	0.6	1.2	0.8	26
28										1.0		0.5	1.0		0.8	0.4	28
30													0.7		0.4	0.1	30
32														0.5		0.1	32
n	10	8	4	7	4	4	4	4	3	3	3	2	2	2	2	n	
S2	0	50	0	100	50	0	100	50	0	100	50	0	100	50	100	S2	
S3	0	0	25	0	25	50	25	50	75	50	75	100	75	100	100	S3	
S4	0	0	25	0	25	50	25	50	75	50	75	100	75	100	100	S4	
S5	0	0	25	0	25	50	25	50	75	50	75	100	75	100	100	S5	

Unit: t

Load Chart of H

H Load Chart Rear Counterweight 0t, Carbody Counterweight 6t, Track Gauge 4.25m (Crawlers Extended), Ground Level 4°																
Radius (m)	Boom length (m)															Radius (m)
	12.2	16.5	18.7	20.9	23	25.2	27.2	29.5	31.8	33.8	36	38.3	40.4	42.5	47	
3	62.5	35.7	30.0	27.1												3
3.5	48.9	35.7	29.5	23.7	24.1											3.5
4	41.3	35.7	26.0	23.0	21.4	21.7										4
4.5	32.1	27.9	25.0	23.0	19.2	20.0	16.2									4.5
5	29.2	25.7	25.0	23.0	19.0	20.0	14.6	15.2								5
5.5	22.5	20.6	22.0	18.5	19.0	20.0	13.9	13.9	12.6							5.5
6	20.3	19.5	21.2	17.6	19.0	20.0	13.9	12.8	12.6	11.0						6
6.5	17.2	15.6	17.3	14.3	15.6	16.6	13.9	12.4	12.6	10.1	10.3					6.5
7	15.3	14.7	16.8	13.8	15.3	16.4	13.9	12.4	12.6	9.5	10.3	8.3	7.0			7
7.5	13.7	11.8	13.6	11.3	12.7	14.1	11.5	12.4	12.6	9.5	10.3	8.3	7.0	5.4		7.5
8	12.4	11.2	13.2	11.0	12.6	13.8	11.4	12.4	12.6	9.5	10.3	8.3	7.0	5.4		8
9	10.2	8.8	10.6	8.5	10.1	11.4	9.5	10.5	11.3	9.5	10.3	8.3	7.0	5.4	4.5	9
10		7.0	8.8	6.7	8.2	9.5	7.9	9.0	9.8	8.1	8.9	8.3	7.0	5.4	4.5	10
11		5.8	7.5	5.3	6.8	8.0	6.4	7.5	8.4	6.9	7.7	7.9	7.0	3.9	4.5	11
12		4.7	6.5	4.2	5.6	6.8	5.3	6.3	7.2	6.0	6.7	7.4	6.1	3.7	4.1	12
14		3.2	4.9	2.5	3.9	5.0	3.5	4.5	5.4	4.2	5.0	5.6	4.6	3.3	3.3	14
16			3.8	1.4	2.7	3.9	2.3	3.3	4.1	3.0	3.7	4.4	3.4	3.0	3.0	16
18				0.5	1.9	3.0	1.4	2.3	3.2	2.0	2.7	3.4	2.5	2.8	2.8	18
20					1.2	2.3	0.7	1.6	2.4	1.3	2.0	2.7	1.7	2.3	2.0	20
22						1.8		1.0	1.9	0.7	1.4	2.1	1.1	1.7	1.4	22
24								0.6	1.4		0.9	1.6	0.7	1.2	0.9	24
26									1.0		0.4	1.2		0.8		26
28									0.7			0.8		0.3		28
n	8	5	4	4	4	3	3	2	2	2	2	2	1	1	1	n
S2	0	50	0	100	50	0	100	50	0	100	50	0	100	50	100	S2
S3	0	0	25	0	25	50	25	50	75	50	75	100	75	100	100	S3
S4	0	0	25	0	25	50	25	50	75	50	75	100	75	100	100	S4
S5	0	0	25	0	25	50	25	50	75	50	75	100	75	100	100	S5

Load Chart of H

H Load Chart
Rear Counterweight 0t, Carbody Counterweight 0t, Track Gauge 2.64m (Crawlers Retracted),
Ground Level 0~1°

Radius (m)	Boom length (m)															Radius (m)
	12.2	16.5	18.7	20.9	23	25.2	27.2	29.5	31.8	33.8	36	38.3	40.4	42.5	47	
3	25.7	21.7														3
3.5	19.5	16.5														3.5
4	17.1	14.7	16.4	12.8												4
4.5	13.2	11.4	13.0	10.0												4.5
5	12.0	10.4	12.2	9.1	10.5	11.7										5
5.5	9.2	8.2	9.8	7.1	8.5	9.5										5.5
6	8.3	7.6	9.4	6.5	8.1	9.2	7.0	8.0								6
6.5	6.4	6.0	7.6	5.1	6.5	7.5	5.6	6.5								6.5
7	5.8	5.5	7.4	4.7	6.2	7.4	5.3	6.4	7.2	5.5						7
7.5	4.5	4.3	5.9	3.6	5.0	6.1	4.2	5.2	6.3	4.5						7.5
8	4.1	3.9	5.6	3.3	4.9	6.1	4.0	5.1	6.0	4.3	5.1					8
9	2.9	2.6	4.3	2.2	3.8	5.0	3.0	4.1	5.0	3.4	4.2		3.5			9
10		1.7	3.3	1.3	2.9	4.0	2.2	3.3	4.2	2.6	3.4	4.1	2.8	3.4		10
11		0.9	2.5	0.6	2.1	3.2	1.5	2.6	3.5	2.0	2.8	3.5	2.2	2.8	2.3	11
12			1.9		1.5	2.5	0.9	2.0	2.9	1.4	2.2	2.9	1.7	2.3	1.8	12
14			0.9			1.5		1.1	1.9		1.3	2.0	0.8	1.5	1.0	14
16						0.8			1.2		0.7	1.4		0.8		16
18									0.6			0.8				18
20																20
22																22
24																24
26																26
28																28
30																30
32																32
34																34
36																36
38																38
40																40
42																42
44																44
n	4	3	3	2	2	2	1	1	1	1	1	1	1	1	1	n
S2	0	50	0	100	50	0	100	50	0	100	50	0	100	50	100	S2
S3	0	0	25	0	25	50	25	50	75	50	75	100	75	100	100	S3
S4	0	0	25	0	25	50	25	50	75	50	75	100	75	100	100	S4
S5	0	0	25	0	25	50	25	50	75	50	75	100	75	100	100	S5

Unit: t

Load Chart of H

H Load Chart Rear Counterweight 0t, Carbody Counterweight 0t, Track Gauge 2.64m (Crawlers Retracted), Ground Level 4°																
Radius (m)	Boom length (m)															Radius (m)
	12.2	16.5	18.7	20.9	23	25.2	27.2	29.5	31.8	33.8	36	38.3	40.4	42.5	47	
3	25.7															3
3.5	19.5															3.5
4	17.1	14.7														4
4.5	13.1	11.4														4.5
5	11.8	10.4	12.2	9.1												5
5.5	9.1	8.2	9.8	7.1												5.5
6	8.1	7.6	9.4	6.6	8.1	9.2										6
6.5	6.3	5.9	7.6	5.1	6.6	7.6										6.5
7	5.7	5.4	7.2	4.7	6.3	7.4	5.3									7
7.5	4.4	4.1	5.8	3.6	5.1	6.1	4.2									7.5
8	4.0	3.7	5.5	3.3	4.9	6.1	4.0	5.1	6.0							8
9	2.8	2.5	4.2	2.2	3.7	4.9	3.0	4.1	5.0	3.4	4.2					9
10		1.6	3.2	1.3	2.8	3.9	2.2	3.3	4.2	2.6	3.4	4.1				10
11		0.8	2.4		2.0	3.1	1.5	2.6	3.5	2.0	2.8	3.5	2.2	2.8		11
12			1.8		1.4	2.5	0.9	2.0	2.8	1.4	2.2	2.9	1.7	2.3		12
14			0.8			1.5		1.0	1.8		1.3	2.0	0.9	1.5	1.0	14
16						0.7			1.1		0.7	1.3		0.8		16
18												0.8				18
20																20
22																22
24																24
26																26
28																28
30																30
32																32
34																34
36																36
38																38
40																40
42																42
44																44
n	4	2	2	2	2	2	1	1	1	1	1	1	1	1	1	n
S2	0	50	0	100	50	0	100	50	0	100	50	0	100	50	100	S2
S3	0	0	25	0	25	50	25	50	75	50	75	100	75	100	100	S3
S4	0	0	25	0	25	50	25	50	75	50	75	100	75	100	100	S4
S5	0	0	25	0	25	50	25	50	75	50	75	100	75	100	100	S5

Load Chart of H

H Load Chart Rear Counterweight 0t, Carbody Counterweight 0t, Track Gauge 3.445m (Crawlers Half Extended), Ground Level 0~1°																
Radius (m)	Boom length (m)															Radius (m)
	12.2	16.5	18.7	20.9	23	25.2	27.2	29.5	31.8	33.8	36	38.3	40.4	42.5	47	
3	45.2	37.8	30.0	32.4												3
3.5	36.1	30.7	30.0	26.6	27.7											3.5
4	29.7	25.5	27.2	22.3	23.6	24.5										4
4.5	25.0	21.6	23.4	19.0	20.4	21.5	18.1									4.5
5	21.4	18.5	20.4	16.4	17.9	19.0	15.8	16.8								5
5.5	18.5	16.0	18.0	14.2	15.7	16.9	14.0	15.0	15.8							5.5
6	16.2	14.0	16.0	12.4	14.0	15.2	12.4	13.4	14.3	12.0						6
6.5	14.3	12.3	14.3	10.9	12.5	13.7	11.0	12.1	13.0	10.8	11.6					6.5
7	12.6	10.8	12.9	9.6	11.2	12.5	9.8	11.0	11.9	9.8	10.6	10.1	9.5			7
7.5	11.0	9.6	11.6	8.4	10.1	11.4	8.8	10.0	10.9	8.8	9.7	9.2	8.6	9.3		7.5
8	9.6	8.5	10.6	7.4	9.1	10.4	7.9	9.1	10.0	8.0	8.9	8.4	7.9	8.5		8
9	7.5	6.7	8.8	5.8	7.4	8.8	6.4	7.6	8.5	6.6	7.5	7.1	6.6	7.3	6.5	9
10		5.3	7.4	4.5	6.1	7.5	5.2	6.4	7.3	5.5	6.4	6.1	5.6	6.3	5.5	10
11		4.0	6.1	3.4	5.0	6.4	4.2	5.4	6.4	4.6	5.4	5.3	4.7	5.4	4.7	11
12		3.0	5.0	2.5	4.2	5.5	3.3	4.5	5.5	3.8	4.6	4.6	4.0	4.7	4.0	12
14		1.4	3.4	1.1	2.7	4.1	2.0	3.2	4.2	2.5	3.4	3.5	2.8	3.5	2.9	14
16			2.2		1.6	2.9	1.0	2.2	3.2	1.5	2.4	2.6	1.8	2.5	2.0	16
18					0.8	2.0		1.4	2.4	0.8	1.7	1.8	1.1	1.8	1.3	18
20						1.3		0.7	1.7		1.0	1.3	0.5	1.2	0.7	20
22						0.8			1.1		0.5	0.8		0.7	0.3	22
24									0.7					0.3		24
26									0.3							26
n	6	5	4	5	4	4	3	3	2	2	2	2	2	2	1	n
S2	0	50	0	100	50	0	100	50	0	100	50	0	100	50	100	S2
S3	0	0	25	0	25	50	25	50	75	50	75	100	75	100	100	S3
S4	0	0	25	0	25	50	25	50	75	50	75	100	75	100	100	S4
S5	0	0	25	0	25	50	25	50	75	50	75	100	75	100	100	S5

Unit: t

Load Chart of H

H Load Chart Rear Counterweight 0t, Carbody Counterweight 0t, Track Gauge 3.445m (Crawlers Half Extended), Ground Level 4°																
Radius (m)	Boom length (m)															Radius (m)
	12.2	16.5	18.7	20.9	23	25.2	27.2	29.5	31.8	33.8	36	38.3	40.4	42.5	47	
3	39.5	22.2	22.6	17.4												3
3.5	29.6	22.2	19.7	15.1	15.9											3.5
4	25.7	22.2	17.7	14.1	14.1	14.8										4
4.5	19.9	17.3	17.7	14.1	12.6	13.3	10.3									4.5
5	18.0	15.9	17.7	14.1	10.1	13.2	9.2	10.0								5
5.5	14.0	12.6	14.3	11.2	10.1	13.2	8.5	9.1	9.7							5.5
6	12.5	11.9	13.8	10.6	12.1	13.2	8.5	8.3	9.0	6.9						6
6.5	11.1	9.4	11.1	8.5	9.9	10.9	8.5	7.8	8.7	6.2	6.9					6.5
7	9.8	8.8	10.7	8.1	9.6	10.8	8.5	7.8	8.7	5.7	6.4	6.1	5.3			7
7.5	8.7	7.0	8.6	6.5	7.9	9.0	7.0	7.8	8.7	5.7	6.4	6.1	4.8	5.4		7.5
8	7.7	6.5	8.3	6.2	7.7	8.9	6.8	7.8	8.7	5.7	6.4	6.1	4.4	5.0		8
9	6.2	4.8	6.6	4.6	6.1	7.3	5.4	6.5	7.4	5.7	6.4	6.1	4.0	4.3	3.5	9
10		3.8	5.5	3.3	4.8	6.0	4.3	5.4	6.3	4.7	5.4	6.1	4.0	3.9	2.9	10
11		2.8	4.6	2.4	3.8	4.9	3.4	4.5	5.3	3.8	4.6	5.3	4.0	3.9	2.5	11
12		2.1	3.8	1.6	2.9	4.1	2.6	3.6	4.5	3.1	3.9	4.6	3.3	3.7	2.4	12
14		0.9	2.6	0.3	1.7	2.9	1.4	2.3	3.2	2.0	2.8	3.4	2.3	2.9	2.4	14
16			1.8		0.9	2.0		1.4	2.2	1.1	1.8	2.5	1.4	2.1	1.6	16
18						1.4		0.7	1.5		1.1	1.8	0.8	1.4	1.0	18
20						0.9			1.0		0.3	1.2		0.9		20
22						0.4			0.6			0.8				22
n	5	3	3	3	2	2	2	2	2	1	1	1	1	1	1	n
S2	0	50	0	100	50	0	100	50	0	100	50	0	100	50	100	S2
S3	0	0	25	0	25	50	25	50	75	50	75	100	75	100	100	S3
S4	0	0	25	0	25	50	25	50	75	50	75	100	75	100	100	S4
S5	0	0	25	0	25	50	25	50	75	50	75	100	75	100	100	S5

Load Chart of H

H Load Chart Rear Counterweight 0t, Carbody Counterweight 0t, Track Gauge 4.25m (Crawlers Extended), Ground Level 0~1°																
Radius (m)	Boom length (m)															Radius (m)
	12.2	16.5	18.7	20.9	23	25.2	27.2	29.5	31.8	33.8	36	38.3	40.4	42.5	47	
3	66.6	54.6	30.0	46.2												3
3.5	51.5	43.3	30.0	37.4	30.0											3.5
4	41.6	35.6	30.0	31.1	30.0	30.0										4
4.5	34.6	29.9	30.0	26.4	27.7	28.5	24.6									4.5
5	29.4	25.5	27.4	22.7	24.1	25.1	21.5	22.4								5
5.5	25.4	22.1	24.0	19.7	21.2	22.3	19.0	19.9	20.6							5.5
6	22.2	19.3	21.3	17.3	18.8	20.0	16.9	17.9	18.7	16.1	15.3					6
6.5	19.6	17.0	19.1	15.3	16.9	18.1	15.1	16.2	17.0	14.6	15.3					6.5
7	17.3	15.1	17.2	13.5	15.2	16.4	13.6	14.7	15.5	13.2	14.0	12.1	12.6			7
7.5	15.1	13.5	15.6	12.1	13.7	15.0	12.2	13.4	14.3	12.0	12.8	12.1	11.7	10.2		7.5
8	13.3	12.1	14.2	10.8	12.4	13.7	11.1	12.2	13.2	11.0	11.8	11.3	10.7	10.2		8
9	10.5	9.8	11.9	8.7	10.3	11.7	9.2	10.3	11.3	9.2	10.1	9.6	9.1	9.8	7.9	9
10		7.8	10.0	7.0	8.7	10.0	7.6	8.8	9.8	7.8	8.7	8.3	7.8	8.5	7.2	10
11		6.2	8.3	5.7	7.3	8.7	6.4	7.5	8.5	6.6	7.5	7.3	6.7	7.4	6.6	11
12		4.9	7.0	4.6	6.2	7.6	5.3	6.5	7.5	5.7	6.5	6.4	5.8	6.5	5.8	12
14		3.0	5.0	2.7	4.3	5.7	3.7	4.8	5.9	4.1	5.0	5	4.3	5.0	4.4	14
16			3.6	1.4	2.9	4.2	2.4	3.6	4.6	2.9	3.8	3.9	3.2	3.9	3.3	16
18				0.3	1.9	3.2	1.4	2.6	3.5	2.0	2.9	3	2.3	3.0	2.5	18
20					1.1	2.3	0.6	1.8	2.7	1.3	2.1	2.3	1.6	2.3	1.8	20
22						1.7		1.1	2.0	0.6	1.5	1.7	1.0	1.7	1.2	22
24								0.5	1.5		1.0	1.2	0.5	1.2	0.7	24
26									1.0		0.5	0.9		0.8	0.3	26
28									0.6					0.4		28
n	9	7	4	6	4	4	4	3	3	3	2	2	2	2	1	n
S2	0	50	0	100	50	0	100	50	0	100	50	0	100	50	100	S2
S3	0	0	25	0	25	50	25	50	75	50	75	100	75	100	100	S3
S4	0	0	25	0	25	50	25	50	75	50	75	100	75	100	100	S4
S5	0	0	25	0	25	50	25	50	75	50	75	100	75	100	100	S5

Unit: t

Load Chart of H

H Load Chart Rear Counterweight 0t, Carbody Counterweight 0t, Track Gauge 4.25m (Crawlers Extended), Ground Level 4°																
Radius (m)	Boom length (m)															Radius (m)
	12.2	16.5	18.7	20.9	23	25.2	27.2	29.5	31.8	33.8	36	38.3	40.4	42.5	47	
3	59.4	31.6	30.0	24.4												3
3.5	43.7	31.6	26.7	21.1	21.6											3.5
4	36.8	31.6	24.2	20.1	19.2	19.6										4
4.5	28.5	24.6	24.2	20.1	17.1	17.8	14.3									4.5
5	25.8	22.6	24.2	20.1	16.7	17.8	12.9	13.5								5
5.5	19.8	18.0	19.6	16.1	16.7	17.8	12.0	12.4	12.5							5.5
6	17.8	17.0	18.8	15.2	16.7	17.8	12.0	11.3	11.9	9.6						6
6.5	15.3	13.5	15.3	12.3	13.7	14.7	12.0	10.8	11.6	8.8	9.4					6.5
7	13.6	12.7	14.8	11.8	13.4	14.5	12.0	10.8	11.6	8.1	8.9	8.3	6.8			7
7.5	12.1	10.1	12.0	9.6	11.1	12.6	9.9	10.8	11.6	8.1	8.9	8.3	6.8	5.4		7.5
8	10.8	9.6	11.6	9.4	10.9	12.1	9.8	10.8	11.6	8.1	8.9	8.3	6.4	5.4		8
9	8.9	7.4	9.3	7.2	8.7	10.0	8.0	9.1	9.9	8.1	8.9	8.3	5.9	5.4	4.5	9
10		5.9	7.7	5.5	7.0	8.3	6.6	7.7	8.6	6.9	7.6	8.3	5.9	5.4	4.5	10
11		4.7	6.5	4.2	5.7	6.9	5.4	6.4	7.3	5.8	6.6	7.3	5.9	4.7	3.9	11
12		3.8	5.6	3.2	4.7	5.8	4.3	5.3	6.2	4.9	5.7	6.4	5.1	4.2	3.4	12
14		2.4	4.1	1.7	3.1	4.3	2.7	3.7	4.6	3.4	4.2	4.8	3.7	3.3	3.3	14
16			3.1	0.7	2.1	3.2	1.6	2.6	3.4	2.3	3.0	3.7	2.7	3.0	2.9	16
18					1.3	2.4	0.8	1.7	2.6	1.4	2.2	2.8	1.9	2.4	2.1	18
20					0.7	1.8		1.1	1.9	0.8	1.5	2.1	1.2	1.8	1.5	20
22						1.3		0.6	1.4		0.9	1.6	0.7	1.2	1.0	22
24									1.0		0.4	1.1		0.8		24
26									0.6			0.8				26
28									0.4							28
n	8	4	4	3	3	3	2	2	2	2	2	2	1	1	1	n
S2	0	50	0	100	50	0	100	50	0	100	50	0	100	50	100	S2
S3	0	0	25	0	25	50	25	50	75	50	75	100	75	100	100	S3
S4	0	0	25	0	25	50	25	50	75	50	75	100	75	100	100	S4
S5	0	0	25	0	25	50	25	50	75	50	75	100	75	100	100	S5

Load Chart of FJ

Load chart -FJ (Ground Level 0~1°)								
Rear Counterweight 26t, Carbody Counterweight 6t, Track Gauge 4.25m (Crawlers Extended)								
Radius(m)	Boom length (m)	47+10.2m jib			47+17.5m jib			Radius(m)
		0°	15°	30°	0°	15°	30°	
8		5.5						8
10		4.9						10
12		4.5	3.6		2.7			12
14		3.8	3.5	3.1	2.4			14
16		3.5	3.3	2.8	2.1	1.8		16
18		3.6	3.1	2.6	2.0	1.7		18
20		3.1	2.9	2.4	1.8	1.6	1.2	20
22		2.7	2.7	2.3	1.7	1.5	1.2	22
24		2.3	2.5	2.1	1.6	1.4	1.1	24
26		1.9	2.3	2.0	1.5	1.3	1.1	26
28		1.7	2.0	1.9	1.4	1.2	1.0	28
30		1.5	1.6	1.7	1.3	1.1	1.0	30
32		1.0	1.3	1.3	1.1	1.0	1.0	32
34				1.0	1.0	0.9	1.0	34
36					0.9	0.9	0.9	36
38							0.9	38
Min. protective angle		50°						Min. protective angle

Unit: t

Load Chart of FJ

Load chart -FJ (Ground Level 4°) Rear Counterweight 26t, Carbody Counterweight 6t, Track Gauge 4.25m (Crawlers Extended)								
Radius(m)	Boom length (m)	47+10.2m jib			47+17.5m jib			Radius(m)
		0°	15°	30°	0°	15°	30°	
11.5		4.2						11.5
14		3.9						14
16		3.6	2.9		2.3			16
18		3.1	2.9	2.4	2.0			18
20		2.9	2.8	2.3	1.8	1.4		20
22		2.8	2.5	2.1	1.6	1.4		22
24		2.5	2.4	1.9	1.4	1.3	0.9	24
26		2.2	2.2	1.8	1.3	1.3	0.9	26
28		1.8	1.9	1.8	1.3	1.2	0.9	28
30		1.5	1.8	1.7	1.3	1.1	0.9	30
32		1.4	1.5	1.5	1.2	1.0	0.8	32
34		1.0	1.2	1.2	1.1	0.9	0.7	34
36		0.7	0.9	0.9	0.9	0.8	0.7	36
38				0.8	0.8	0.8	0.7	38
40						0.7	0.6	40
42							0.6	42
Min. protective angle		50°						Min. protective angle

Note: rated capacity of crane

1. The rated load in the load chart is calculated complying with EN13000.
2. The crawlers of crane must be extended during lifting;
3. All ratings in the table are calculated when the machine is sitting on firm and level ground with less than 1% gradient, and the load lifting is slowly and steadily.
4. All ratings in the table are calculated with wind speed under 9.8m/s and tipping load of 75%.
5. All ratings in the table are valid for 360° slewing.
6. The rated load is no more than 5.5t when using boom point sheave block. If the jib is extended, the boom rated load shall reduce 2.3t.
7. The ratings in the table include the weight of hook block and riggings (main hook block of 1.05t, aux. hook block of 0.35t). The weight of hook, riggings and wire ropes shall be deducted from the ratings to get the actual load capacity.

Foundation Purposes Load Chart

Foundation purposes Load Chart (Ground Level 0~1°) Rear Counterweight 26t, Carbody Counterweight 6t, Track Gauge 4.25m (Crawlers Extended)																
Boom length (m) Radius(m)	12.2	16.5	18.7	20.9	23	25.2	27.2	29.5	31.8	33.8	36	38.3	40.4	42.5	47	Boom length (m) Radius(m)
3	75	52.2														3
3.5	71.9	49.9														3.5
4	68	47.6	30	38												4
4.5	65	45.3	30	36.6	30	24.9										4.5
5	58	43	30	35.2	30	24.8	26.7									5
5.5	54	41.1	30	33.8	30	24.7	25.8	19.6								5.5
6	48.8	39.1	29	32.4	29	24.1	24.8	19.6	12.3	18.1	10.6					6
6.5	45	37.2	29	31	29	23.4	24	19.6	12.3	17.7	10.6	8.1				6.5
7	40.3	35.2	29	29.6	27.8	22.7	23	19.6	12.3	17.4	10.6	8.1	8.3			7
7.5	37.2	33	28	28.2	26.6	21.9	22.2	19.6	12.3	17	10.6	8.1	8.3			7.5
8	32.4	30.8	28	26.8	25.7	21.2	21.4	18.7	12.3	16.6	10.6	8.1	8.3			8
9	26.8	26.6	26.1	24.4	24.1	20.2	20	17.7	12	15.8	10.6	8.1	8.3		5.6	9
10		22.4	23	21.4	22.2	19.1	18.6	16.8	11.7	14.9	10.6	8.1	8.3	6.4	5.6	10
11		19.2	19.9	18.5	19.5	18.1	17.5	15.9	11.3	14.1	10.6	8.1	8.3	6.4	5.6	11
12		16.7	17.2	15.6	16.8	17	16.5	14.9	11	13.2	10.6	8.1	8.3	6.4	5.6	12
14			12.8	11.6	12.8	13.6	13.3	13.1	10.2	11.9	9.9	7.7	8	6.4	5.6	14
16				8.8	9.8	10.8	10.2	10.4	9.3	10.5	9.2	7.2	7.6	6.4	5.6	16
18					7.8	8.8	8	8.3	8.5	8.4	8.5	6.7	7.3	6.3	5.6	18
20						7.4	6.4	6.9	7.5	6.9	7.3	6.1	6.9	6.1	5.6	20
22							5.2	5.6	6.2	5.7	6.1	5.7	6.1	5.7	5.5	22
24								4.6	5.1	4.6	5.1	5.4	5	5.3	5.3	24
26									4.4	3.8	4.3	4.7	4.1	4.6	4.6	26
28										3.1	3.6	4	3.4	3.9	3.9	28
30											3	3.5	2.8	3.3	3.4	30
32												3	2.3	2.85	2.8	32
34													1.8	2.3	2.4	34
36															1.8	36
Parts of Line	10	7	4	5	4	4	4	3	2	3	2	2	2	1	1	Parts of Line
Section 2	0	50	0	100	50	0	100	50	0	100	50	0	100	50	100	Section 2
Section 3	0	0	25	0	25	50	25	50	75	50	75	100	75	100	100	Section 3
Section 4	0	0	25	0	25	50	25	50	75	50	75	100	75	100	100	Section 4
Section 5	0	0	25	0	25	50	25	50	75	50	75	100	75	100	100	Section 5



Zhejiang Sany Equipment Co.,LTD

SANY Crawler Crane Industrial Park, No. 2188 Daishan Road, Wuxing District, Huzhou City,
Zhejiang Province, P. R. China Zip 313028
Consulting sanycrane@sanygroup.com (Crane BU) / crd@sany.com.cn (IHQ)
After-sales Service 0086-400 6098 318

Reminder:

Any change in the technical parameters and configuration due to product modification or upgrade may occur without prior notice.
The machine in the picture may include additional equipment. This brochure is for reference only, and goods in kind shall prevail.
Copyright at SANY. No part of this brochure may be copied or used for any purpose without written approval from SANY.

© Edited in April 2023

