



# SCE1000A

## Crawler Crane

### 100 Tons Lifting Capacity

Quality Changes the World



**Max. lifting moment: 380t·m**  
**Max. boom length: 64m**  
**Max. fixed jib combination: 52m+22.5m**

The parameters, pictures and standard/optional equipment are only for reference in this brochure, the actual machine is based on the effective price list and contract.

■ [www.sanyglobal.com](http://www.sanyglobal.com)



## Crawler Crane Series SCE1000A

P03

Main  
Characteristics

- Product Specification
- Safety Device

P09

Technical  
Parameters

- Major Performance & Specifications
- Outline Dimension
- Transport Dimension
- Transport Plan 1
- Transport Plan 2

P18

Configurations

- H Configuration
- FJ Configuration
- HC Configuration



**SCE1000A**  
**SANY CRAWLER CRANE**  
**100 TONS LIFTING CAPACITY**

QUALITY CHANGES THE WORLD

## Main Characteristics

- Page 04 Product Specification
- Page 07 Safety Device



## Product Specification



### Engine

- Model: Cummins QSL9-C325 Diesel engine;
- Type: 4-stroke, water-cooled, vertical in-line 6 cylinders, direct injection, turbo-charger, intercooler, complied with European Non-road Tier V Emission Standard and US EPA Tier F4(f) Emission Standard;
- Displacement: 8.9L;
- Rated power: 242kW/1800rpm;
- Operation power: 242kW/1800rpm;
- Max. Torque: 1526N.m/1400rpm;
- Starter: 24V-7.8kW;
- Radiator: fin type aluminum plate core;
- Air cleaner: Dry type system with main filter element, safety element and resistance indicator;
- Throttle: Hand throttle, foot throttle, electrically-controlled;
- Fuel filter: Replaceable paper element;
- Batteries: Two 12V×165Ah capacity batteries, connected in series (24V system);
- Fuel tank capacity: 400L.

### Electrical Control System

- Self-developed SYIC-II integrated control system is adopted with higher integration, precise operation and reliable quality;
- Control system consists of power system, engine system, main control system, LML system, auxiliary system and safety monitoring system. CAN BUS is used for data communication between controller, monitor and the engine;
- Monitor: the working parameters and status are shown on the monitor, such as the engine speed, fuel volume, engine oil pressure, servo pressure, engine working hours, lifting conditions and boom angle.

### Hydraulic System

- Main pumps: three open variable displacement piston pumps are adopted to provide oil supply for main actuators of machine;
- Gear pump: two types of gear pump for radiator and control circuit;
- Control: main pump adopts electrically-controlled positive flow control; winch motor adopts limitless adjustable piston motor of variable displacement. The operating components are two cross hydraulic handles, dual one-axis control handle for travel (EU market); or one cross handle plus three one-axis handles, and dual one-axis handles (US and other markets), to control various actuators proportionally;
- Way of cooling: heat exchanger, plate fan core and multi-stage cooling;
- Filter: large flow, high precision filter, with bypass valve and transmitter, which can remind the user to replace the filter element in time;
- Max. pressure of system: 32MPa;
- Main/aux. load hoist, boom hoist and travel system: 32MPa;
- Swing system: 32MPa;
- Control system: 5MPa;
- Hydraulic Tank Capacity: 460L.



## Product Specification

### Main and Aux. Hoist Mechanism

- Main and aux. hoist winches are driven separately by motor via gearbox. Operating winch handle can control the winch to rotate to two directions, which are lifting and lowering of hook. Excellent inching function is equipped on the machine;
- Drums with fold-line grooves can ensure the wire rope reeved in order in multilayers;
- Free fall for main/aux. load hoist is offered as optional.

Main Hoisting Mechanism	Drum diameter	630mm
	Rope speed on the first work layer	0~121m/min
	Wire rope diameter	26mm
	Wire rope length of main hoist	240m
	Rated single line pull	12t
Auxiliary Hoisting Mechanism	Drum diameter	630mm
	Rope speed on the first work layer	0~121m/min
	Wire rope diameter	26mm
	Wire rope length of auxiliary hoist	180m
	Rated single line pull	12t

### Boom Hoist Mechanism

- Boom hoist winch is driven separately by motor via gearbox. Operating handle can control the winch to rotate to two directions, which are lifting and lowering of boom;
- Drums with fold-line grooves can ensure the wire rope reeved in order in multilayers.

Boom Hoist Mechanism	Drum diameter	420mm
	Rope speed on the first work layer	0~59m/min
	Wire rope diameter	20mm
	Wire rope length of boom hoist	140m
	Rated single line pull	7t

### Optional 3rd winch mechanism

- Optional 3rd winch mechanism is connected with boom base with pins and driven separately by motor via gearbox. Operating handle can control the winch to rotate to two directions, which are lifting and lowering of hook;
- Drums with fold-line grooves can ensure the wire rope reeved in order in multilayers.

Optional 3rd Winch Mechanism	Drum diameter	522mm
	Rope speed on the outermost work layer	0~100m/min
	Wire rope diameter	22mm
	Wire rope length	130m
	Rated single line pull	9t

### Swing Mechanism

- Swing brake adopts wet, spring loaded, normally-closed brake, and braking through spring force;
- Swing system has three work modes to accommodate different needs. It is featured in small backlash, steady control, and excellent inching function. It also has free slipping function and swing control on slope to provide smoother braking;
- Swing drive: internal engaged swing drive with 360° swing range, and the max. swing speed is 2.7r/min. The max. drive pressure can reach 32MPa;
- Swing lock: cylinder lock can ensure the upperworks locked securely on four directions after work or during transport; Swing ring: single row ball bearing.

### Cab and Control

- Novel operator's cab with fashionable profile, nice interior and large window glass. There are low and high-beam lights, back-view mirror, heater and A/C, radio and other functions. The layout of seat, handles, control buttons are designed with ergonomic principles to make operation more comfortable;
- Cab layout: Integrated 10.4-inch touch screen, programmable smart switches, and man-machine interaction interface are more improved;
- Armrest box: on the left and right armrest box are control handles, electrical switches, emergent stop and ignition switch. The armrest box can be adjusted along with the seat;
- Seat: multi-way and multi-level floating adjustable seat with unload switch;
- A/C: cool and heat air; optimized air channels and vents;
- Multiple cameras can present on the monitor at the same time to realize backing video, real-time monitoring of wire rope on each winch, conditions behind the counterweight and surrounding the machine.

### Counterweight

- Counterweight tray and blocks are piled up for easier assembly and transport;
- Rear counterweight is self-assembled, total 31.2t;
- Self-assembled counterweight: tray 9.9t×1, left counterweight block 3.45t×3, and right counterweight block 3.45t×3, cylinder bracket 0.6×1;
- Carbody counterweight: 5.5t×2 at the front and rear of carbody.

### Upperworks

- High-strength steel weld framework. The parts are laid out in the way that is easier for maintenance and service.

## Product Specification



### Lowerworks

- Independent travel driving units are adopted for each side of the crawler, to realize straight walking and turning driven by travel motor through gearbox and drive wheel.

### Crawler Extension and Retraction

- The crawlers can extend and retract via cylinders. During Work Mode, the crawlers must be extended, and retracted during transport with crawlers on when there is no restrictions.

### Crawler Tensioning

- Use the jack to push the guide wheel and insert the shim to adjust crawler tension.

### Track Pad

- High-strength alloy cast steel track pad can prolong the service life. They are 850mm wide, and the total amount is 53pcs×2.

### Jack cylinder

- Jack cylinders are provided as standard offering to make jobsite transfer easier.

### Self-assembly cylinder

- Self-assembly cylinder is provided as standard offering to help crawlers and carbody counterweight assembly during jobsite transfer.

### Operating Equipment

- All chords are high-strength steel tubes, and the boom/jib top sheaves are made of high-strength anti-wearing Nylon material protecting wire rope. The hooks are installed with rolled welded steel sheave. Pendant cables with quick hitch connector that are easy to assemble are adopted.

### Boom

- Lattice structure. The chord adopts high-strength structural tube and each section is connected through pins;
- Basic boom: 6.5m boom top + 6.5m boom base;
- Boom insert: 3m×1, 6m×2, 9m×4;
- Boom length: 13m~64m.

### Fixed Jib

- Lattice structure. The chord adopts high-strength structural tube and each section is connected through pins;
- Basic boom: 4.5m boom top + 4.5m boom base;
- Boom insert: 4.5m×3;
- Boom length: 9m~22.5m;
- Longest boom + jib: 52m boom +22.5m jib.

### Extension Jib

- The extension jib is a welded structure connected to the boom tip by pins, used for auxiliary hook;
- Extension jib length: 1.66m.

### Hook Block

- 100t hook block, five sheaves;
- 50t hook block, three sheaves;
- 25t hook block, one sheave;
- 13.5t ball hook.



## Safety Device

### Assembly Mode/Work Mode Switch

- In Assembly Mode, some safety devices are disabled for crane assembly;
- In Work Mode, all safety devices activate to protect the operation.

### Emergent Stop

- In emergent situation, this button is pressed down to cut off the power supply of whole machine and all actions stop.

### Load Moment Limiter (LML)

- It is an independent computerized safety control system. LML can automatically detect the load weight, work radius and boom angle, and present on the display the rated load, actual load, work radius and boom angle. In normal operation, the LML can make a judgment and cut off automatically if the crane moves towards dangerous direction. It can also perform as a black box to record the lifting information;
- Composition: monitor, angler sensor, force sensor and other electrical components.

### Over-hoist Protection of the Main/Auxiliary Hooks

- Over-hoist protection device comprises of limit switch and weight on boom top, which prevents the hook lift up too much. When the hook lifts up to the limit height, the limit switch activates, buzzer on the left control panel sends alarm, and failure indicator light starts to flash, the hook hoisting action is cut off automatically.

### Over-release Protection Device of the Main/Auxiliary Winch

- It is comprised of activator in the drum and proximity switch to prevent over release of wire rope. When the rope is paid out close to the last three wraps, the limit switch acts, and the system sends alarm through buzzer and show the alarm on the instrument panel, automatically cutting off the winch action.

### Function Lock

- If the function lock level is not in work position, all the other handles won't work, which prevents any mis-operation caused by accidental collision.

### Drum Lock

- Hydraulically controlled lock is installed for boom hoist drum, which needs to unlock by switch before operation, in order to prevent mis-operation of handles and ensure safety during non-work time.

### Swing Lock

- Swing Lock can lock the machine at four positions, front and back, left and right.

### Boom Limit Device

- When the boom elevation angle reaches the maximum angle the buzzer sounds and boom action cut off. This protection is two-stage control ensured by both LML system and travel switch.

### Back-stop Device

- Its major components are tubes and spring, in order to buffer the boom backlash and prevent further tipping back.

### Boom Angle Indicator

- Pendulum angle indicator is fixed on the side of boom base close to the cab, so as to provide convenience to the operator.

### Hook Latch

- The lifting hook is installed with a baffle plate to prevent wire rope from falling off.

## Safety Device



### Monitoring System

- Remote Monitoring system is a standardized offering to provide functions like GPS locating, GPRS data transfer, machine status inquiry and statistics, operating data monitoring and analysis, remote diagnosis of failures.

### Lightning Protection Device

- It is offered as an optional feature, which includes the grounding device that can effectively protect the electric system elements and workers from lightning.

### Tri-color Load Indicator

- The load indication light has three colors, green, yellow and red, and the real time load status is presented on the display. When the actual load is smaller than 90% of rated load, the green light is on; when the actual load is larger than 90% and smaller than 100%, the yellow light is on, the alarm light flashes and sends out intermittent sirens; when the actual load reaches 102% of rated load, the red light on, the alarm light flashes and sends out continuous sirens. At this moment, the system will automatically cut off the crane's dangerous operation.

### Audio-Visual Alarm

- It flashes once the machine is powered on with electricity, so as to warn people around.

### Swing Indicator Light

- The swing indicator light flashes during traveling or swing.

### Illuminating Light

- The machine is equipped with, short-beam light in front of machine, front angle adjustable far-beam, lamps in operator's cab, lighting devices for night operation, so as to increase the visibility during work.

### Rearview Mirror

- It is installed on the left of the operator's cab for monitoring the rear part of the machine.

### Pharos

- Pharos is mounted on the top of boom/jib to indicating the height.

### Anemometer

- It is mounted on the top of boom/jib, and displayed on the monitor in the cab.

### Electronic Level Gauge

- It displays the tipping angle of crane on the monitor in real time, protecting the machine from dangerous situation.

### Operation Release

- If the operator leaves the seat, all control handles will be locked immediately to prevent any mis-operation due to accidental collision.

### Engine Power Limit Load Adjustment and Stalling Protection

- The controller monitors the engine power to prevent engine getting stuck and stalling.

### Engine Status Monitoring

- The engine status will be presented, such as engine coolant temperature, fuel volume, total work hours, engine oil pressure, engine speed, battery charging, voltage.





**SCE1000A**  
**SANY CRAWLER CRANE**  
**100 TONS LIFTING CAPACITY**

QUALITY CHANGES THE WORLD

## Technical Parameters

- Page 10 Major Performance & Specifications
- Page 11 Outline Dimension
- Page 12 Transport Dimension
- Page 16 Transport Plan 1
- Page 17 Transport Plan 2

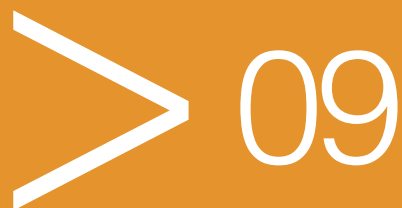

## Major Performance & Specifications

Major Performance & Specifications of SCE1000A			
Performance Indicators		Unit	Parameter
H	Max. rated lifting capacity	t	100
	Max. lifting moment	t·m	100×3.8=380
	Boom length	m	13~64
	Boom luffing angle	°	30~80
FJ	Max. rated lifting capacity	t	11
	Jib length	m	9~22.5
	Longest boom + longest jib	m	52+22.5
	Jib angle	°	15\30
Speed	Rope speed of main/aux. winch (1st layer)	m/min	121
	Rope speed of boom hoist winch (1st layer)	m/min	59
	Swing speed	rpm	2.7
	Travel speed	km/h	2\1
Wire rope	Main hoist wire rope: diameter × length	φ mm×m	φ 26×240
	Aux. hoist wire rope: diameter × length	φ mm×m	φ 26×180
	Single line pull of main/aux. hoist wire rope	t	12
Engine	Output power	kW	242
	Rated speed	rpm	1800
Transport	Weight of machine with basic boom	t	97.4
	Transport weight of basic machine (with boom base, crawlers and 4 winches)	t	53.3
	Transport weight of basic machine (without crawlers)	t	34.3
	Machine transport dimension (with boom base, crawlers and 4 winches)L×W×H	mm	13300×3490×3460
	Machine transport dimension (without crawlers )L×W×H	mm	8310×3000×3070
Other specifications	Average ground pressure (basic boom)	MPa	0.10
	Gradeability	%	30

Unit: mm

## Outline Dimension

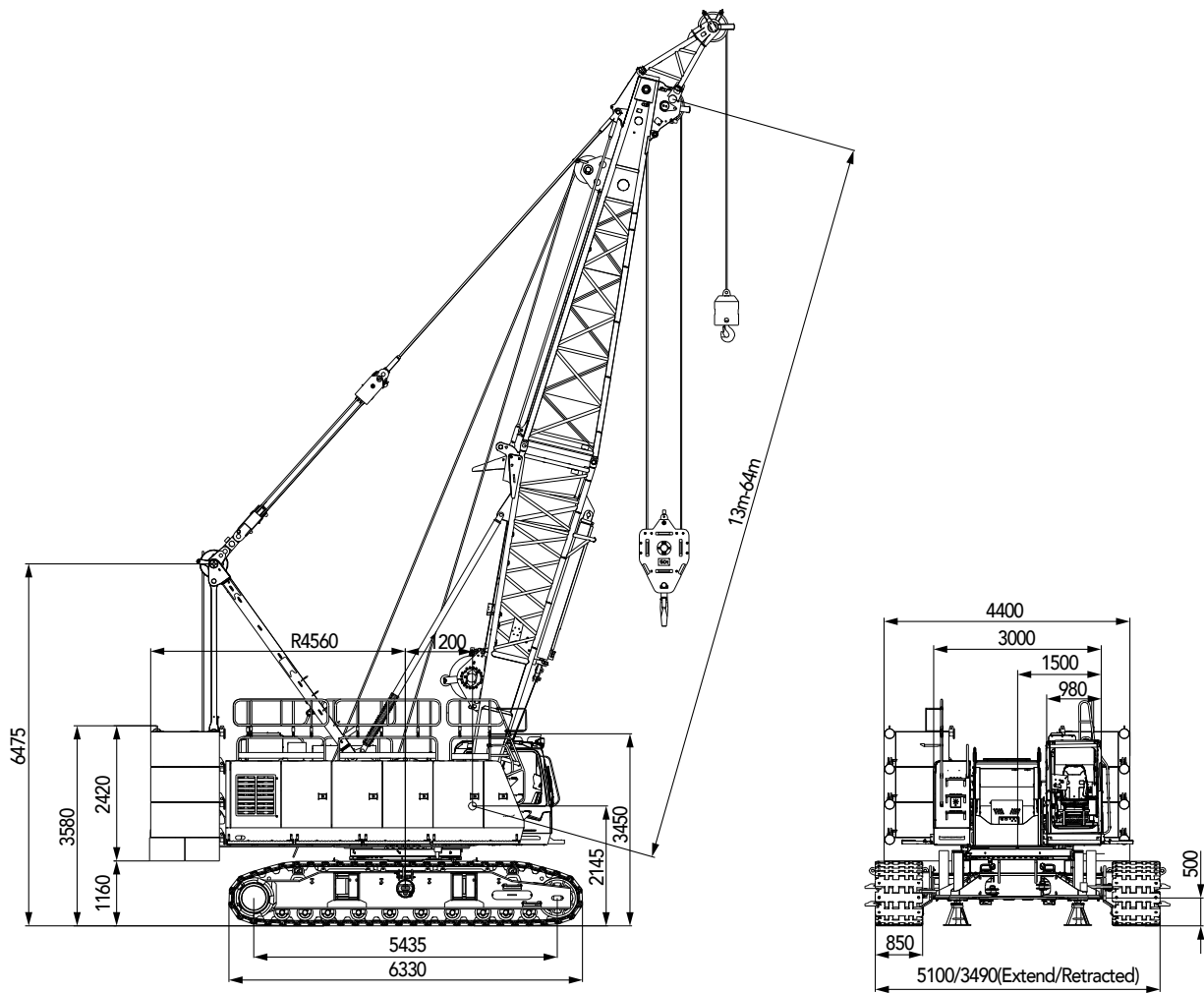

## Transport Dimension

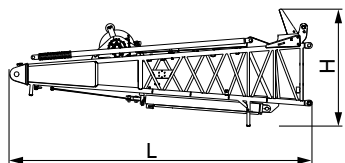
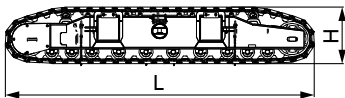
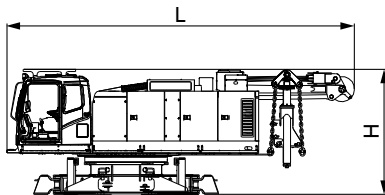
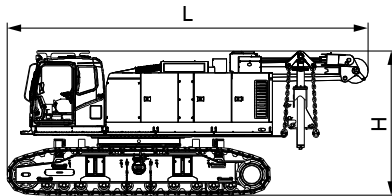
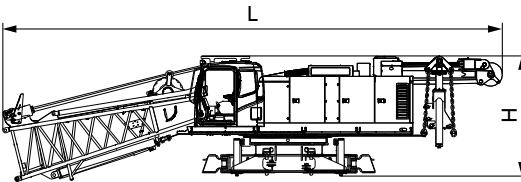
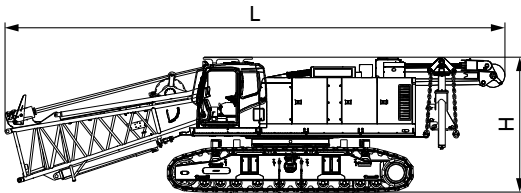

### Basic Machine 1 (with boom base , crawlers and 4 winches ) ×1

Length(L)	13.30m
Width(W)	3.49m
Height(H)	3.46m
Weight with 3rd winch	53.3t
Weight without 3rd winch	52.26t

### Basic Machine 2 (with boom base and 4 winches ) ×1

Length (L)	13.30m
Width (W)	3.00m
Height (H)	3.07m
Weight with 3rd winch	34.3t
Weight without 3rd winch	33.26t

### Basic Machine 3 (with crawlers and 3 winches) ×1

Length (L)	8.67m
Width (W)	3.49m
Height (H)	3.46m
Weight	49.86t

### Basic Machine 4 ×1

Length(L)	8.31m
Width(W)	3.00m
Height(H)	3.07m
Weight	30.86t

### Crawlers ×2

Length(L)	6.33m
Width(W)	1.09m
Height(H)	1.15m
Weight	9.5t

### Boom Base With the 3rd Winch ×1

Length(L)	6.72 m
Width(W)	1.78m
Height(H)	2.06m
Weight	3.58t

Note: weight of the optional 3rd winch is 1.04t.

## Transport Dimension

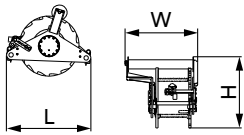

3rd Winch	×1
Length(L)	1.11m
Width(W)	0.95m
Height(H)	0.94m
Weight	1.04t

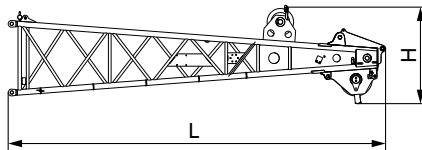

Boom Top	×1
Length(L)	7.13m
Width(W)	1.49m
Height(H)	1.79m
Weight	1.50t

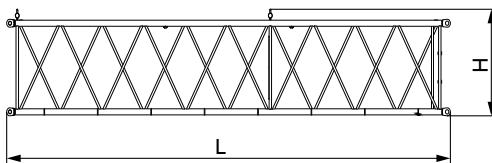

9m Boom Insert	×4
Length (L)	9.14m
Width (W)	1.51m
Height (H)	1.47m
Weight	1.07t

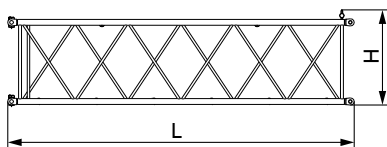

6m Boom Insert	×2
Length (L)	6.14m
Width (W)	1.51m
Height (H)	1.47m
Weight	0.78t

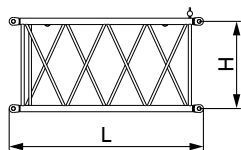

3m Boom Insert	×1
Length(L)	3.14m
Width(W)	1.51m
Height(H)	1.47m
Weight	0.50t

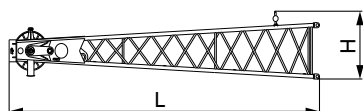

Fixed Jib Top	×1
Length(L)	4.93m
Width(W)	0.87m
Height(H)	0.92m
Weight	0.31t

## Transport Dimension

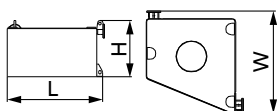
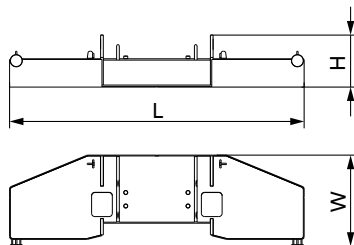
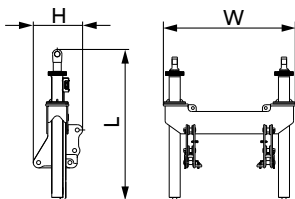
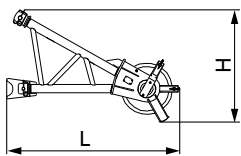
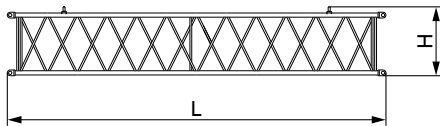
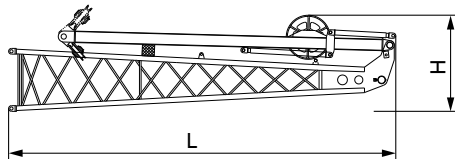

### Fixed Jib Base and Strut

×1

Length(L)	4.75m
Width(W)	0.87m
Height(H)	1.18m
Weight	0.75t

### 4.5m Fixed Jib

×3

Length(L)	4.57m
Width(W)	0.87m
Height(H)	0.83m
Weight	0.24t

### Extension Jib

×1

Length (L)	1.82m
Width (W)	0.90m
Height (H)	1.20m
Weight	0.2t

### Counterweight Cylinder Bracket

×1

Length(L)	2.28m
Width(W)	1.98m
Height(H)	0.74m
Weight	1.4t

Note: weight includes that for chains and pendant bar

### Counterweight Tray

×1

Length (L)	4.40m
Width (W)	1.35m
Height (H)	0.77m
Weight	9.9t

### Left Counterweight Block

×3

Length (L)	1.33m
Width (W)	1.26m
Height (H)	0.72m
Weight	3.45t

## Transport Dimension

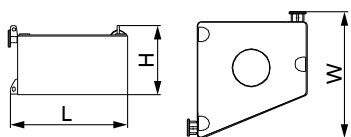

Right Counterweight Block	×3
Length(L)	1.33m
Width(W)	1.26m
Height(H)	0.72m
Weight	3.45t

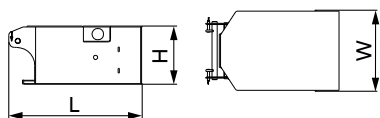

Carbody Counterweight	×2
Length(L)	1.85m
Width(W)	1.13m
Height(H)	0.81m
Weight	5.5t

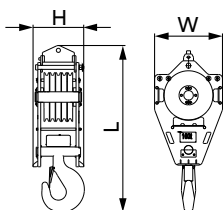

100t Hook	×1
Length (L)	2.08m
Width (W)	0.85m
Height (H)	0.63m
Weight	1.36t

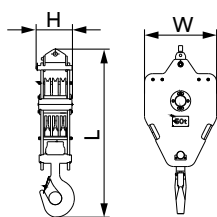

50t Hook	×1
Length(L)	1.95m
Width(W)	0.90m
Height(H)	0.45m
Weight	1.04t

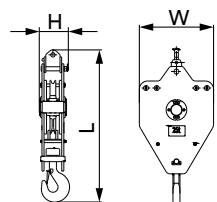

25t Hook	×1
Length(L)	1.86m
Width(W)	0.90m
Height(H)	0.35m
Weight	0.79t

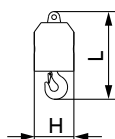

13.5t Ball Hook	×1
Length(L)	0.95m
Width(W)	0.43m
Height(H)	0.43m
Weight	0.45t

Note:

- 1.The transport dimensions of each part in the table are schematic, not proportional to the real parts. The dimensions are designed value without package considered.
- 2.The Weight is designed value that the actual manufactured part may deviate a little.

## Transport Plan 1

Trailer 1	
Part(s)	▪ Basic machine with 4 winches
Weight	▪ 34.3t

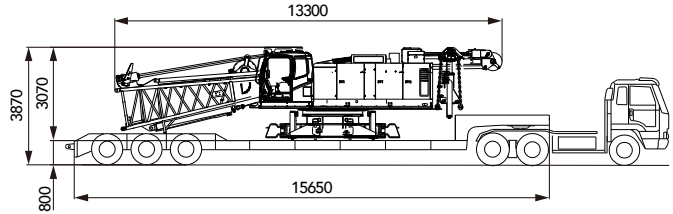

Trailer 2	
Part(s)	▪ 9m boom ×2 ▪ 6m boom ×1 ▪ 3m boom ×1 ▪ Extension jib ×1 ▪ 4.5m fixed jib ×3 ▪ Left crawler frame ×1 ▪ Right crawler frame ×1
Weight	▪ 23.4t

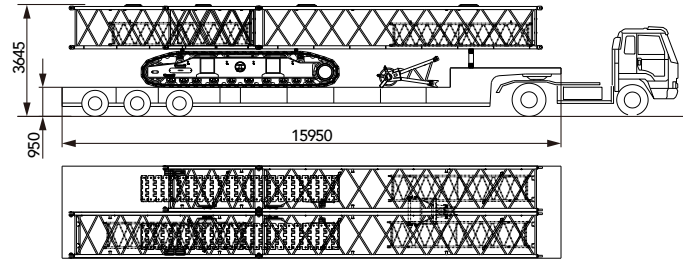

Trailer 3	
Part(s)	▪ 9m boom ×2 ▪ 6m boom ×1 ▪ Boom top ×1 ▪ Fixed jib base ×1 ▪ Fixed jib top ×1 ▪ Left counterweight block ×3 ▪ Right counterweight block ×3
Weight	▪ 26.4t

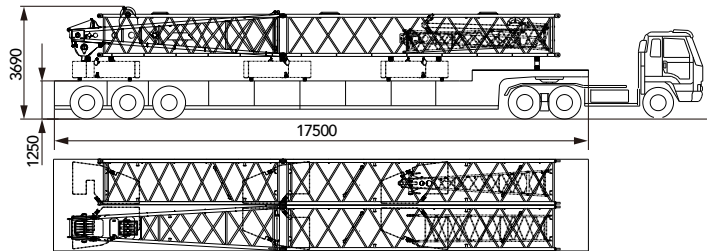

Trailer 4	
Part(s)	▪ Counterweight tray ×1 ▪ Carbody counterweight ×2 ▪ 100t hook ×1 ▪ 50t hook ×1 ▪ 25t hook ×1 ▪ 13.5t ball hook ×1
Weight	▪ 24.6t

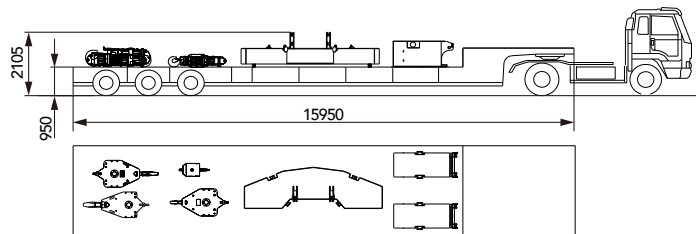



## Transport Plan 2

Trailer 1	
Part(s)	<ul style="list-style-type: none"> <li>Basic machine with 4 winches</li> </ul>
Weight	<ul style="list-style-type: none"> <li>53.3t</li> </ul>

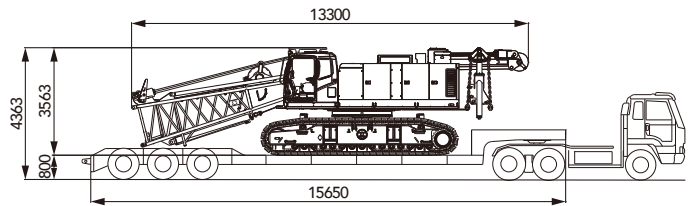

Trailer 2	
Part(s)	<ul style="list-style-type: none"> <li>9m boom x2</li> <li>6m boom x1</li> <li>3m boom x1</li> <li>Extension jib x1</li> <li>4.5m fixed jib x3</li> <li>Carbody counterweight x2</li> <li>Left counterweight x1</li> <li>Right counterweight x1</li> <li>100t hook x1</li> <li>50t hook x1</li> <li>25t hook x1</li> <li>13.5t hook x1</li> </ul>
Weight	<ul style="list-style-type: none"> <li>26t</li> </ul>

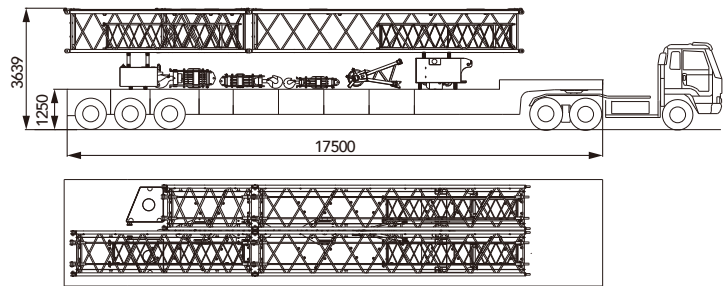

Trailer 3	
Part(s)	<ul style="list-style-type: none"> <li>9m boom x2</li> <li>6m boom x1</li> <li>Boom top x1</li> <li>Fixed jib base x1</li> <li>Fixed jib top x1</li> <li>Counterweight tray x1</li> <li>Left counterweight x2</li> <li>Right counterweight x2</li> </ul>
Weight	<ul style="list-style-type: none"> <li>29.5t</li> </ul>

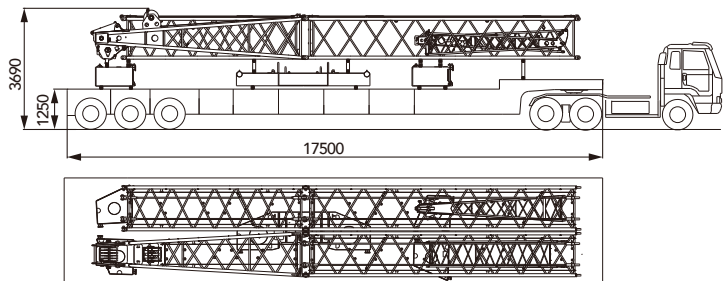



**SCE1000A**  
**SANY CRAWLER CRANE**  
**100 TONS LIFTING CAPACITY**

QUALITY CHANGES THE WORLD

## Configuration

- Page 20 H Configuration
- Page 26 FJ Configuration
- Page 32 HC Configuration

> 18

**Combination**

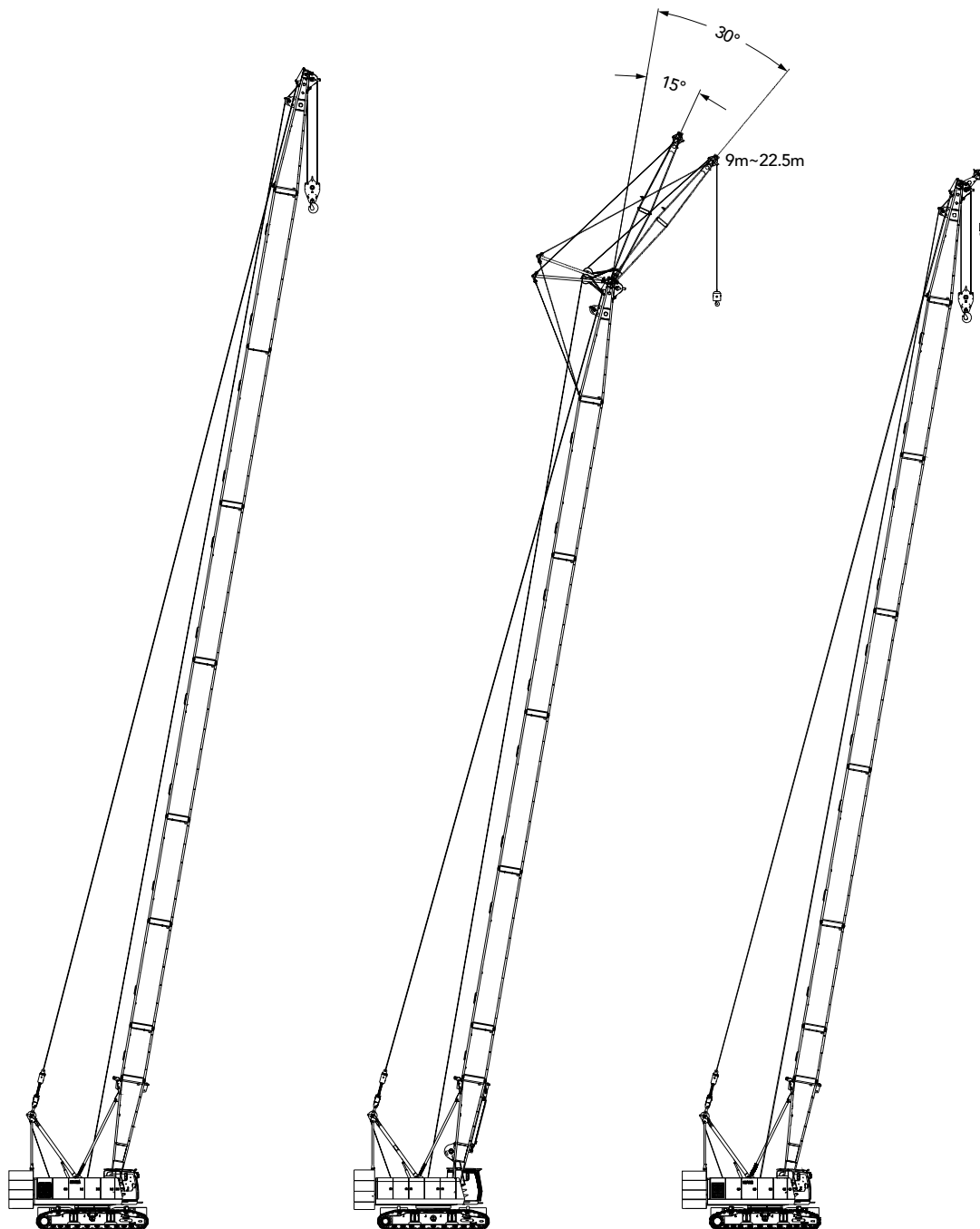

**H Configuration**  
13m~64m

**FJ Configuration**  
31m~52m

**HC Configuration**  
13m~58m

## Boom Combination in H

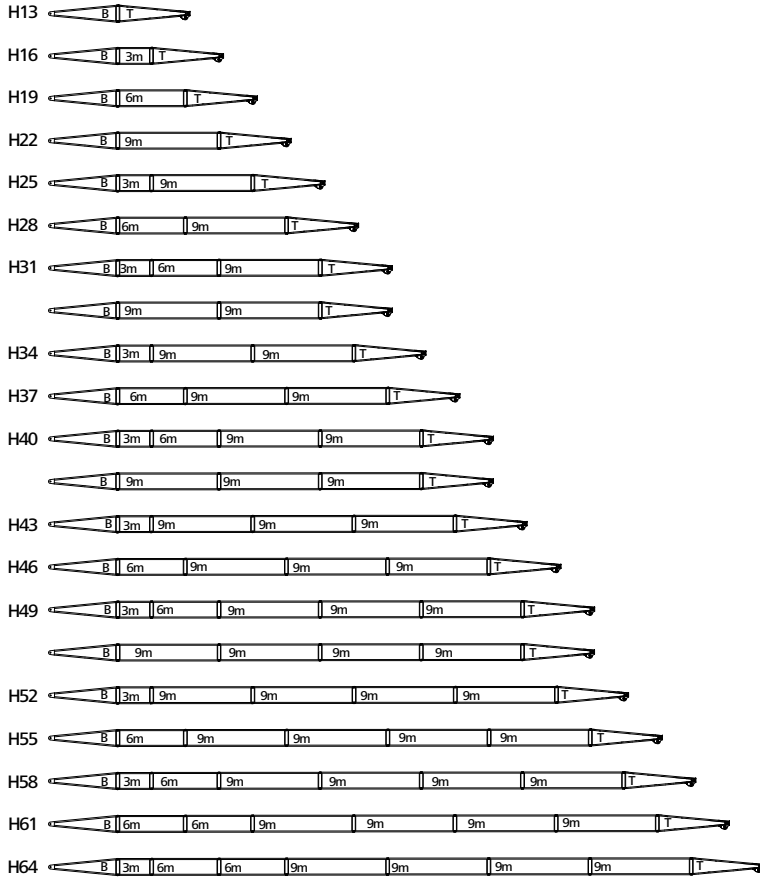

(6.5m) Boom Base



(3m) Boom Insert



(6m) Boom Insert



(9m) Boom Insert



(6.5m) Boom Top

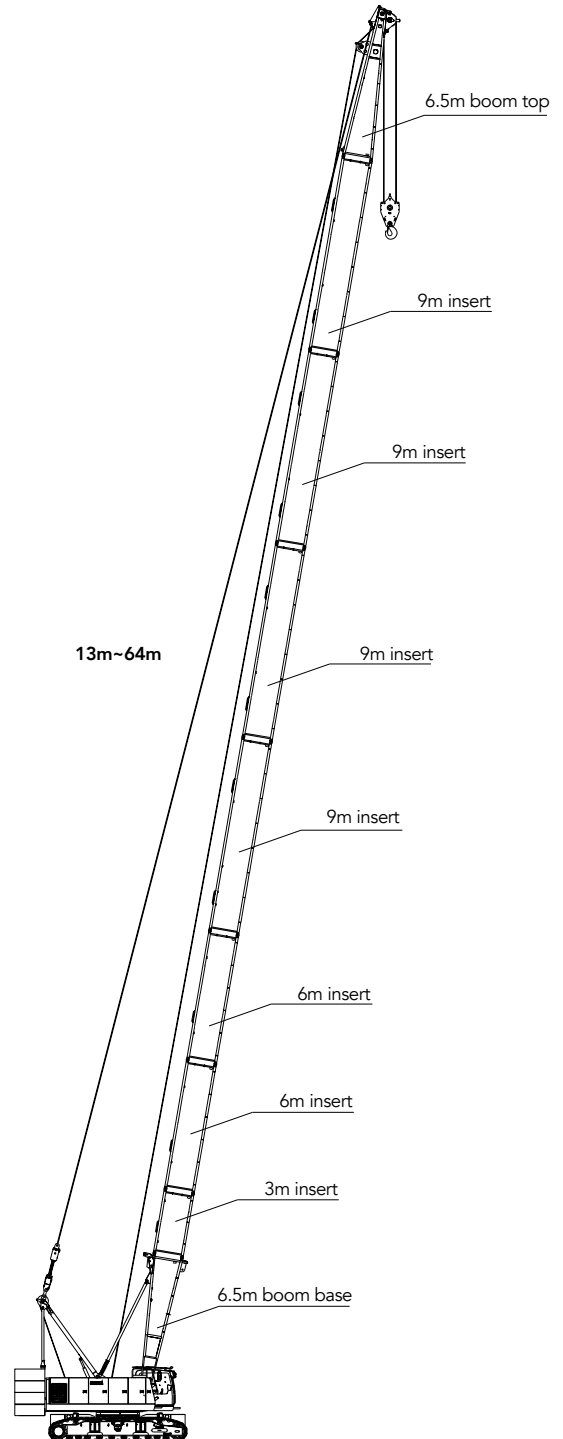

## Working Radius in H Configuration

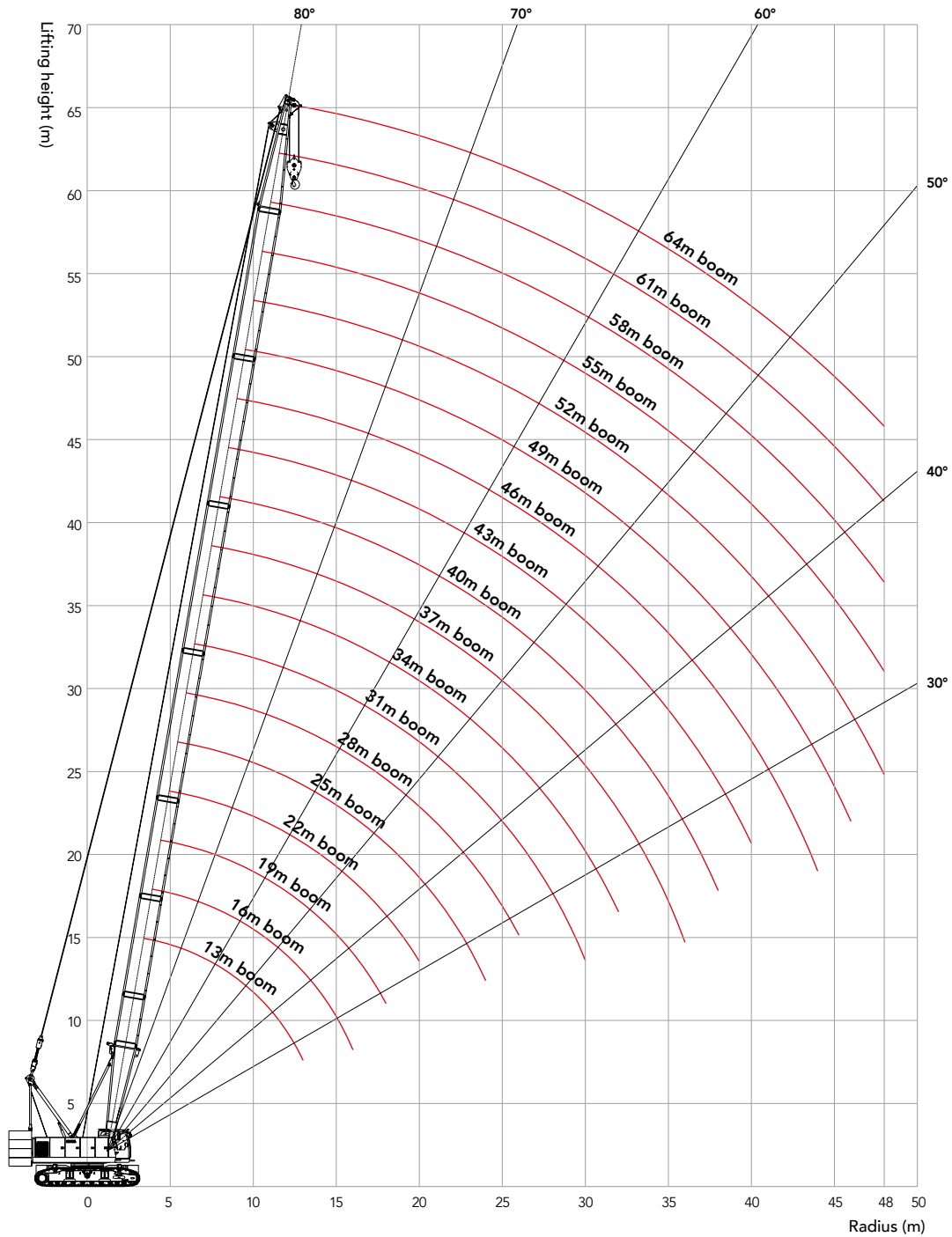

## Load Chart of H Configuration

- Note:
- 1.The rated load in the load chart is calculated complying with EN 13000;
  - 2.The working radius is the horizontal distance from the load center to the swing center;
  - 3.The actual lifting capacity must subtract the weight of hooks and other riggings from the rated capacity in the load chart.
  - 4.The load value is calculated when the object is hung freely,without considering the influence of wind on the load, ground conditions and slope, operation speed and the influence of any other negative factors over safe operation. Therefore, the operator bears the responsibility of making a judgment and decreasing the load and lowering speed.
  - 5.All ratings are calculated when the machine is parking on firm and level ground with less than 1% gradient.
  6. The load value is calculated with wind speed of 9.8m/s.
  7. More detailed information needs to refer to Operator Manual.
  8. This note is applicable to all the following load charts.

Load chart -H (Rear counterweight 31.2t, Carbody counterweight 11t) 1/2

R/BL (m)	13	16	19	22	25	28	31	34	37	R/BL (m)
3.8	100									3.8
4	90									4
4.5	84.2	82								4.5
5	75	73								5
5.5	69	68.8	68.2							5.5
6	62.9	62.2	61.4	59.2						6
6.5	55.6	55.1	54.6	53.8	52					6.5
7	49.9	49.4	49	48.6	47.6	46.2				7
7.5	45.1	44.7	44.3	44	43.6	42.7	41.5			7.5
8	41.2	40.8	40.5	40.2	39.8	39.5	38.6	37.5		8
9	35.1	34.7	34.4	34.2	33.9	33.6	33.4	32.9	32.1	9
10	30.5	30.1	29.9	29.7	29.4	29.2	28.9	28.7	28.4	10
11	26.9	26.6	26.4	26.2	25.9	25.7	25.5	25.2	25	11
12	24	23.7	23.5	23.4	23.1	22.9	22.7	22.5	22.3	12
13	21.7	21.4	21.2	21	20.8	20.6	20.4	20.2	20	13
14		19.5	19.3	19.1	18.9	18.7	18.5	18.3	18.2	14
15		17.8	17.7	17.5	17.3	17.1	16.9	16.7	16.6	15
16		16.4	16.3	16.1	15.9	15.7	15.6	15.3	15.2	16
18			14	13.8	13.6	13.5	13.3	13.1	12.9	18
20				12.1	11.8	11.7	11.6	11.3	11.2	20
22					10.4	10.3	10.1	9.9	9.8	22
24					9.3	9.1	9	8.8	8.6	24
26						8.2	8	7.8	7.7	26
28							7.2	7	6.9	28
30							6.5	6.3	6.2	30
32								5.7	5.6	32
34									5	34
36									4.6	36

Unit: t

## Load Chart of H Configuration

Load chart -H (Rear counterweight 31.2t, Carbody counterweight 11t) 2/2										
R/BL (m)	40	43	46	49	52	55	58	61	64	R/BL (m)
9	31.4									9
10	27.9	27.2								10
11	24.8	24.5	23.9	23.4						11
12	22.1	21.9	21.7	21.2	20.7					12
13	19.9	19.6	19.5	19.3	18.9	18.1	16			13
14	18	17.8	17.6	17.4	17.2	16.9	15.4	14.2		14
15	16.4	16.2	16	15.9	15.6	15.5	14.8	13.6	11.8	15
16	15	14.8	14.7	14.5	14.3	14.1	13.9	12.9	10.5	16
18	12.8	12.6	12.4	12.3	12.1	11.9	11.7	11.6	9.8	18
20	11.1	10.8	10.7	10.6	10.3	10.2	10	9.9	8.8	20
22	9.7	9.4	9.3	9.2	9	8.8	8.6	8.5	7.8	22
24	8.5	8.3	8.2	8	7.8	7.7	7.5	7.4	6.8	24
26	7.6	7.3	7.2	7.1	6.9	6.7	6.5	6.4	5.8	26
28	6.7	6.5	6.4	6.3	6.1	5.9	5.7	5.6	5.2	28
30	6	5.8	5.7	5.6	5.4	5.2	5	4.9	4.5	30
32	5.4	5.2	5.1	5	4.8	4.6	4.4	4.3	3.9	32
34	4.9	4.7	4.6	4.4	4.2	4.1	3.9	3.8	3.4	34
36	4.4	4.2	4.1	4	3.8	3.6	3.4	3.3	2.9	36
38	4	3.8	3.7	3.6	3.3	3.2	3	2.9	2.5	38
40		3.4	3.3	3.2	3	2.9	2.6	2.5	2.1	40
42			3	2.8	2.6	2.5	2.3	2.2	1.8	42
44			2.7	2.5	2.3	2.2	2	1.9	1.5	44
46				2.3	2.1	1.9	1.7	1.6	1.2	46
48					1.8	1.7	1.5	1.3	1	48

## Instructions on H load chart with reduced counterweight

1. Please follow the instructions in the Operator Manual to set properly via Menu Setting – Configuration Setting – Counterweight Selection.
2. Machine rear counterweight is about 23.5t, with rear counterweight tray, two left counterweight blocks, two right counterweight blocks, no carbody counterweight.

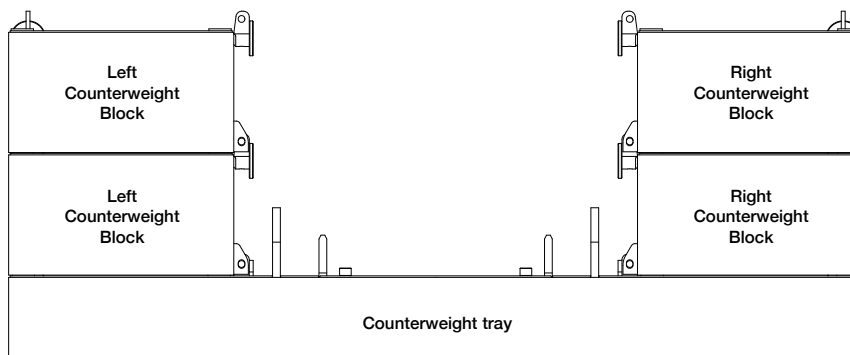



Unit: t

### H load chart with reduced counterweight

H Configuration with less counterweight																
About 23.5t Rear Counterweight (Rear counterweight tray, two left and two right counterweight blocks) + 0t Carbody Counterweight																
R/BL (m)	13	16	19	22	25	28	31	34	37	40	43	46	49	52	55	R/BL (m)
4	90															4
4.5	76															4.5
5	65.1	62.2														5
5.5	55.4	54.7	52.5													5.5
6	48.2	47.7	47	45.2												6
6.5	42.6	42.2	41.8	41	39.6											6.5
7	38.2	37.8	37.4	37.1	36.2	35.1										7
7.5	34.5	34.1	33.8	33.6	33.2	32.4	31.5									7.5
8	31.5	31.1	30.9	30.6	30.3	30	29.2	28.3								8
9	26.7	26.4	26.2	26	25.7	25.5	25.2	24.7	24.1							9
10	23.2	22.9	22.7	22.5	22.2	22	21.8	21.6	21.4	20.8	20.2					10
11	20.4	20.1	19.9	19.8	19.5	19.3	19.2	18.9	18.7	18.6	18.1	17.7	17.2			11
12	18.2	17.9	17.8	17.6	17.3	17.2	17	16.8	16.6	16.4	16.2	15.9	15.5	15.1		12
13	16.4	16.1	16	15.8	15.6	15.4	15.2	15	14.9	14.7	14.5	14.3	14.1	13.7	13.3	13
14		14.6	14.5	14.3	14.1	13.9	13.8	13.6	13.4	13.3	13	12.9	12.7	12.5	12.1	14
15		13.4	13.2	13.1	12.8	12.7	12.5	12.3	12.2	12	11.8	11.7	11.5	11.3	11.1	15
16		12.3	12.1	12	11.7	11.6	11.5	11.2	11.1	11	10.7	10.6	10.5	10.2	10.1	16
18			10.4	10.2	10	9.9	9.7	9.5	9.4	9.2	9	8.9	8.7	8.5	8.4	18
20				8.8	8.6	8.5	8.4	8.1	8	7.9	7.7	7.5	7.4	7.2	7.1	20
22					7.5	7.4	7.3	7.1	6.9	6.8	6.6	6.5	6.3	6.1	6	22
24					6.6	6.5	6.4	6.2	6	5.9	5.7	5.6	5.4	5.2	5.1	24
26						5.8	5.6	5.4	5.3	5.2	5	4.8	4.7	4.5	4.4	26
28							5	4.8	4.7	4.5	4.3	4.2	4.1	3.9	3.7	28
30							4.4	4.2	4.1	4	3.8	3.7	3.5	3.3	3.2	30
32								3.8	3.6	3.5	3.3	3.2	3.1	2.9	2.7	32
34									3.2	3.1	2.9	2.8	2.6	2.4	2.3	34
36									2.9	2.7	2.5	2.4	2.3	2.1	2	36
38										2.4	2.2	2.1	2	1.8	1.6	38
40											1.9	1.8	1.7	1.5	1.3	40
42												1.5	1.4	1.2	1.1	42

## Boom Combination of FJ Configuration

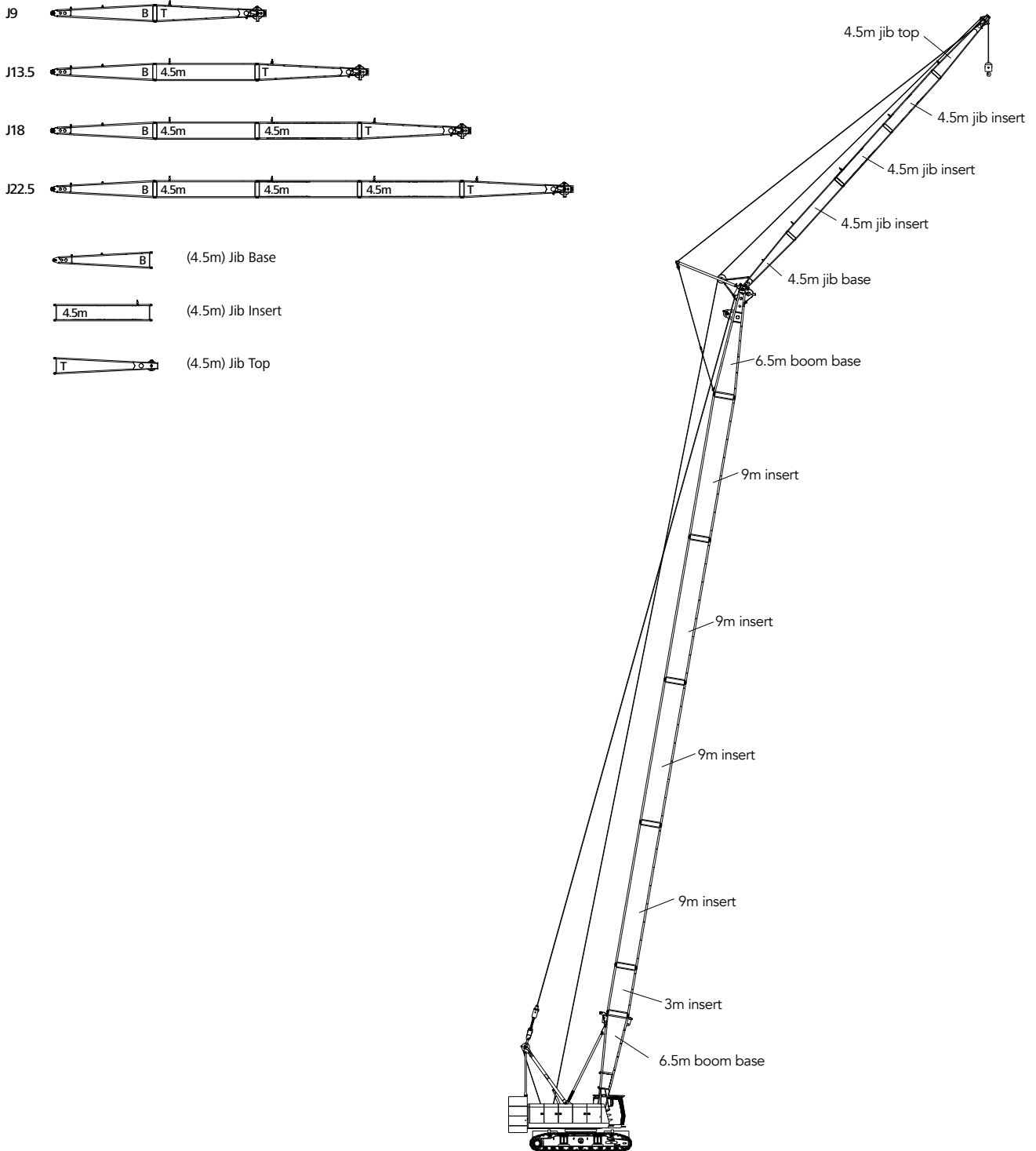

## Working Radius in FJ Configuration

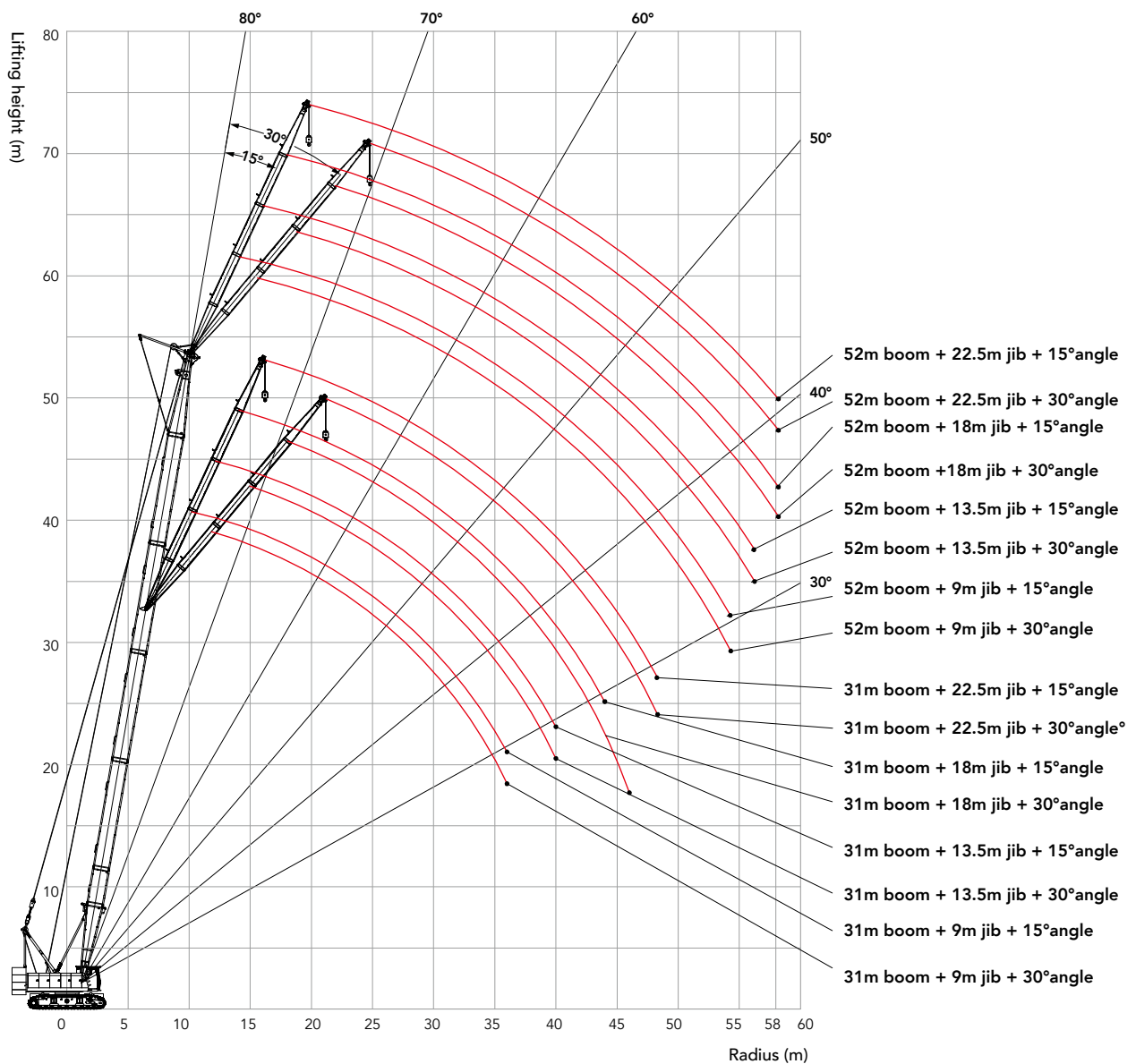

## Load Chart of FJ Configuration

Load chart -FJ (Rear counterweight 31.2t, Carbody counterweight 11t) 1/4																	
R/BL (m)	31								34								R/BL (m)
Jib Length (m)	9		13.5		18		22.5		9		13.5		18		22.5		Jib Length (m)
Boom to Jib Angle	15°	30°	15°	30°	15°	30°	15°	30°	15°	30°	15°	30°	15°	30°	15°	30°	Boom to Jib Angle
12	11																12
13	11								11								13
14	11	11	11						11	11							14
15	11	11	11						11	11	11						15
16	11	11	11	10.3	11				11	11	11		11				16
18	11	11	11	9.7	10.5			7.1	11	11	11	9.7	10.5		7.2		18
20	11	11	11	9.1	9.7	7.2	6.7		11	11	11	9.1	9.7	7.2	6.8		20
22	10.4	10.5	10.5	8.7	9	6.8	6.3	5.7	10.2	10.4	10.3	8.7	9	6.8	6.4	5.8	22
24	9.2	9.3	9.3	8.3	8.4	6.4	6	5.3	9	9.2	9.1	8.3	8.4	6.4	6.1	5.5	24
26	8.2	8.3	8.3	7.9	7.9	6.1	5.7	5	8	8.2	8.1	7.9	7.9	6.1	5.8	5.2	26
28	7.4	7.5	7.5	7.6	7.4	5.9	5.5	4.8	7.2	7.3	7.3	7.5	7.3	5.9	5.6	5	28
30	6.7	6.8	6.7	6.9	6.8	5.6	5.2	4.6	6.5	6.6	6.6	6.8	6.6	5.6	5.3	4.8	30
32	6	6.1	6.1	6.3	6.1	5.4	5	4.4	5.8	5.9	5.9	6.1	6	5.4	5.1	4.6	32
34	5.5	5.5	5.6	5.7	5.6	5.2	4.8	4.3	5.3	5.4	5.4	5.5	5.4	5.2	4.9	4.4	34
36	5	5	5.1	5.2	5.1	5.1	4.6	4.2	4.8	4.9	4.9	5	4.9	5.1	4.7	4.3	36
38			4.7	4.7	4.7	4.8	4.5	4	4.4	4.4	4.5	4.6	4.5	4.7	4.5	4.1	38
40			4.3	4.3	4.3	4.4	4.3	3.9			4.1	4.2	4.1	4.2	4.2	4	40
42					3.9	4	4	3.8			3.7	3.8	3.8	3.9	3.9	3.9	42
44					3.6	3.7	3.7	3.7				3.4	3.4	3.5	3.6	3.7	44
46						3.3	3.5	3.5					3.1	3.2	3.4	3.4	46
48							3.2	3.2							3.1	3.1	48

Note: the capacity values in shade are determined by single line pull or boom strength.

Unit: t

## Load Chart of FJ Configuration

Load chart -FJ (Rear counterweight 31.2t, Carbody counterweight 11t) 2/4																		
R/BL (m)	37								40								R/BL (m)	
Jib Length (m)	9		13.5		18		22.5		9		13.5		18		22.5		Jib Length (m)	
Boom to Jib Angle	15°	30°	15°	30°	15°	30°	15°	30°	15°	30°	15°	30°	15°	30°	15°	30°	Boom to Jib Angle	
13	11								11								13	
14	11								11								14	
15	11	11	11						11								15	
16	11	11	11						11	11	11						16	
18	11	11	11	9.7	10.5				11	11	11		10.5				18	
20	11	11	11	9.1	9.7		6.9		11	11	11	9.1	9.7		6.9		20	
22	10	10.3	10.1	8.7	9	6.8	6.5		9.9	10.1	10	8.7	9	6.8	6.6		22	
24	8.9	9.1	9	8.3	8.4	6.4	6.2	5.6	8.7	8.9	8.8	8.3	8.4	6.4	6.3	5.6	24	
26	7.9	8	8	7.9	7.9	6.1	5.9	5.3	7.7	7.9	7.9	7.9	7.9	6.1	6	5.4	26	
28	7.1	7.2	7.2	7.4	7.2	5.9	5.7	5.1	6.9	7.1	7	7.3	7.1	5.9	5.8	5.2	28	
30	6.3	6.5	6.4	6.6	6.5	5.6	5.5	4.9	6.2	6.3	6.3	6.5	6.4	5.6	5.6	5	30	
32	5.7	5.8	5.8	6	5.9	5.4	5.2	4.7	5.6	5.7	5.7	5.9	5.7	5.4	5.3	4.8	32	
34	5.2	5.3	5.3	5.4	5.3	5.2	5	4.5	5	5.2	5.1	5.3	5.2	5.2	5.1	4.7	34	
36	4.7	4.8	4.8	4.9	4.8	5	4.8	4.3	4.6	4.7	4.6	4.8	4.7	4.9	4.7	4.5	36	
38	4.3	4.3	4.3	4.5	4.4	4.6	4.4	4.2	4.1	4.2	4.2	4.4	4.3	4.5	4.3	4.3	38	
40	3.9	3.9	4	4.1	4	4.1	4	4.1	3.7	3.8	3.8	3.9	3.9	4	3.9	4.1	40	
42	3.5	3.6	3.6	3.7	3.6	3.8	3.7	3.8	3.4	3.4	3.5	3.6	3.5	3.7	3.6	3.8	42	
44			3.3	3.3	3.3	3.4	3.4	3.5	3.1	3.1	3.2	3.2	3.2	3.3	3.3	3.5	44	
46			3	3	3	3.1	3.1	3.3			2.9	2.9	2.9	3	3	3.2	46	
48					2.7	2.8	2.8	3			2.6	2.6	2.6	2.7	2.7	2.9	48	
50					2.5	2.5	2.6	2.7					2.4	2.5	2.5	2.6	50	
52							2.3	2.4					2.1	2.2	2.2	2.3	52	
54														2	2	2.1	54	

Note: the capacity values in shade are determined by single line pull or boom strength.

## Load Chart of FJ Configuration

Load chart -FJ (Rear counterweight 31.2t, Carbody counterweight 11t) 3/4																		
R/BL (m)	43								46								R/BL (m)	
Jib Length (m)	9		13.5		18		22.5		9		13.5		18		22.5		Jib Length (m)	
Boom to Jib Angle	15°	30°	15°	30°	15°	30°	15°	30°	15°	30°	15°	30°	15°	30°	15°	30°	Boom to Jib Angle	
14	11																14	
15	11								11								15	
16	11	11	11						11								16	
18	11	11	11			10			11	11	11						18	
20	11	11	11	9.1		9.7		7	11	11	11		9.1	9.6			20	
22	9.7	10	9.8	8.7		9	6.8	6.7		9.6	9.9	9.7	8.7	8.9		6.8	22	
24	8.5	8.8	8.7	8.3		8.4	6.4	6.4	5.7	8.4	8.7	8.5	8.3	8.4	6.4	6.5	5.8	24
26	7.6	7.8	7.7	7.9		7.8	6.1	6.1	5.5	7.4	7.6	7.6	7.9	7.6	6.1	6.2	5.6	26
28	6.7	6.9	6.8	7.1		6.9	5.9	5.9	5.3	6.6	6.8	6.7	7	6.8	5.9	5.9	5.4	28
30	6	6.2	6.1	6.4		6.2	5.6	5.6	5.1	5.9	6.1	6	6.3	6.1	5.6	5.7	5.2	30
32	5.4	5.5	5.5	5.7		5.6	5.4	5.4	4.9	5.3	5.4	5.4	5.6	5.4	5.4	5.4	4.9	32
34	4.9	5	5	5.2		5	5.2	5	4.8	4.7	4.9	4.8	5	4.9	5.2	4.9	4.6	34
36	4.4	4.5	4.5	4.6		4.5	4.8	4.6	4.6	4.2	4.4	4.3	4.5	4.4	4.7	4.4	4.4	36
38	3.9	4	4	4.2		4.1	4.3	4.1	4.4	3.8	3.9	3.9	4.1	4	4.2	4	4.2	38
40	3.6	3.6	3.6	3.8		3.7	3.9	3.8	4	3.4	3.5	3.5	3.7	3.6	3.8	3.7	3.9	40
42	3.2	3.3	3.3	3.4		3.3	3.5	3.5	3.6	3.1	3.2	3.2	3.3	3.2	3.4	3.4	3.6	42
44	2.9	2.9	3	3.1		3	3.2	3.1	3.3	2.8	2.8	2.8	3	2.9	3.1	3	3.2	44
46	2.6	2.6	2.7	2.8		2.7	2.9	2.8	3	2.5	2.5	2.6	2.7	2.6	2.8	2.7	2.9	46
48			2.4	2.5		2.4	2.6	2.5	2.7	2.2	2.3	2.3	2.4	2.3	2.5	2.4	2.6	48
50			2.2	2.2		2.2	2.3	2.2	2.4		2	2	2.1	2.1	2.2	2.2	2.3	50
52				2		2	2.1	2	2.2			1.8	1.9	1.9	2	1.9	2.1	52
54						1.8	1.8	1.8	1.95			1.6	1.6	1.6	1.7	1.7	1.8	54
56						1.6	1.6	1.6	1.7					1.4	1.5	1.5	1.6	56
58								1.4	1.5					1.3	1.3	1.3	1.4	58

Note: the capacity values in shade are determined by single line pull or boom strength.

Unit: t

## Load Chart of FJ Configuration

Load chart -FJ (Rear counterweight 31.2t, Carbody counterweight 11t) 4/4																	
R/BL (m)	49								52								R/BL (m)
Jib Length (m)	9		13.5		18		22.5		9		13.5		18		22.5		Jib Length (m)
Boom to Jib Angle	15°	30°	15°	30°	15°	30°	15°	30°	15°	30°	15°	30°	15°	30°	15°	30°	Boom to Jib Angle
15	11								11								15
16	11								11								16
18	11	11	11						11	11	10.4						18
20	10.9	11	10.8	9.1	9				10.7	11	10.1		8.3				20
22	9.4	9.7	9.6	8.7	8.7		6.8		9.3	9.6	9.3	8.7	8.1				22
24	8.3	8.5	8.4	8.3	8	6.4	6.5		8.1	8.4	8.2	8.3	7.8	6.4	6.7		24
26	7.3	7.5	7.4	7.8	7.5	6.1	6.3	5.4	7.1	7.4	7.3	7.6	7.4	6.1	6.4	5.4	26
28	6.5	6.7	6.6	6.9	6.7	5.9	6.1	5.2	6.3	6.5	6.4	6.8	6.5	5.9	6.1	5.1	28
30	5.8	5.9	5.9	6.2	6	5.6	5.7	5	5.6	5.8	5.7	6	5.8	5.6	5.8	4.8	30
32	5.1	5.3	5.3	5.5	5.3	5.4	5.3	4.7	5	5.1	5.1	5.4	5.2	5.4	5.2	4.6	32
34	4.6	4.7	4.7	4.9	4.8	5.1	4.8	4.5	4.4	4.6	4.5	4.8	4.6	4.9	4.7	4.4	34
36	4.1	4.3	4.2	4.4	4.3	4.6	4.3	4.3	3.9	4.1	4	4.3	4.1	4.4	4.2	4.2	36
38	3.7	3.8	3.8	4	3.8	4.1	3.9	4.1	3.5	3.6	3.6	3.8	3.7	4	3.8	4	38
40	3.3	3.4	3.4	3.6	3.4	3.7	3.5	3.8	3.1	3.2	3.2	3.4	3.3	3.5	3.4	3.7	40
42	3	3.1	3	3.2	3.1	3.3	3.2	3.5	2.8	2.9	2.9	3	2.9	3.2	3.1	3.4	42
44	2.6	2.7	2.7	2.9	2.8	3	2.9	3.1	2.5	2.5	2.5	2.7	2.6	2.8	2.7	3	44
46	2.4	2.4	2.4	2.6	2.5	2.7	2.6	2.8	2.2	2.2	2.2	2.4	2.3	2.5	2.4	2.7	46
48	2.1	2.1	2.2	2.3	2.2	2.4	2.3	2.5	1.9	2	2	2.1	2	2.2	2.1	2.4	48
50	1.9	1.9	1.9	2	2	2.1	2.1	2.3	1.7	1.7	1.7	1.8	1.8	1.9	1.8	2.1	50
52	1.6	1.7	1.7	1.8	1.7	1.9	1.8	2	1.4	1.5	1.5	1.6	1.6	1.7	1.6	1.8	52
54			1.5	1.5	1.5	1.6	1.6	1.8	1.2	1.3	1.3	1.4	1.3	1.5	1.4	1.6	54
56			1.3	1.3	1.3	1.4	1.4	1.5			1.1	1.2	1.1	1.3	1.2	1.4	56
58					1.1	1.2	1.2	1.3					1	1	1	1.2	58

Note: the capacity values in shade are determined by single line pull or boom strength.

## Boom Combination of HC Configuration

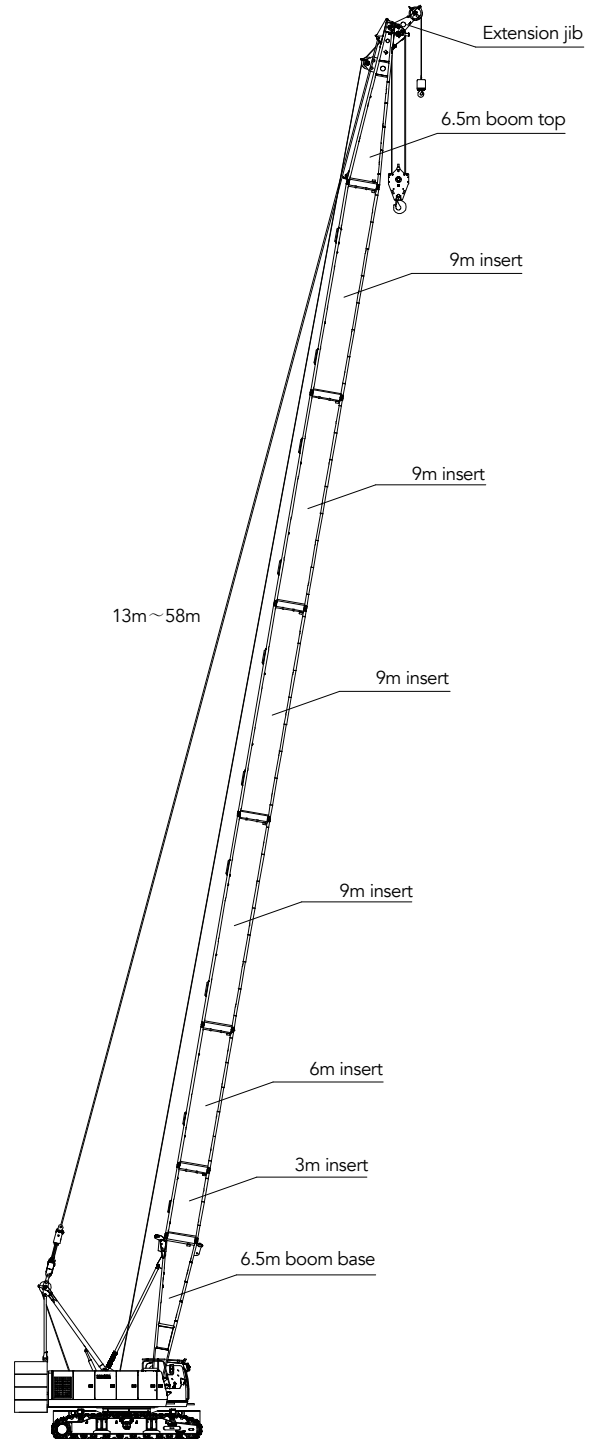
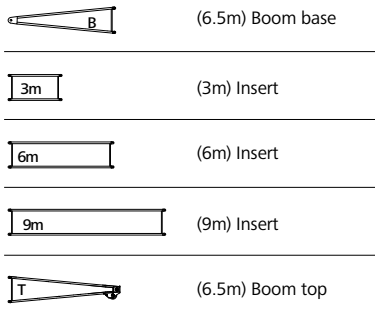
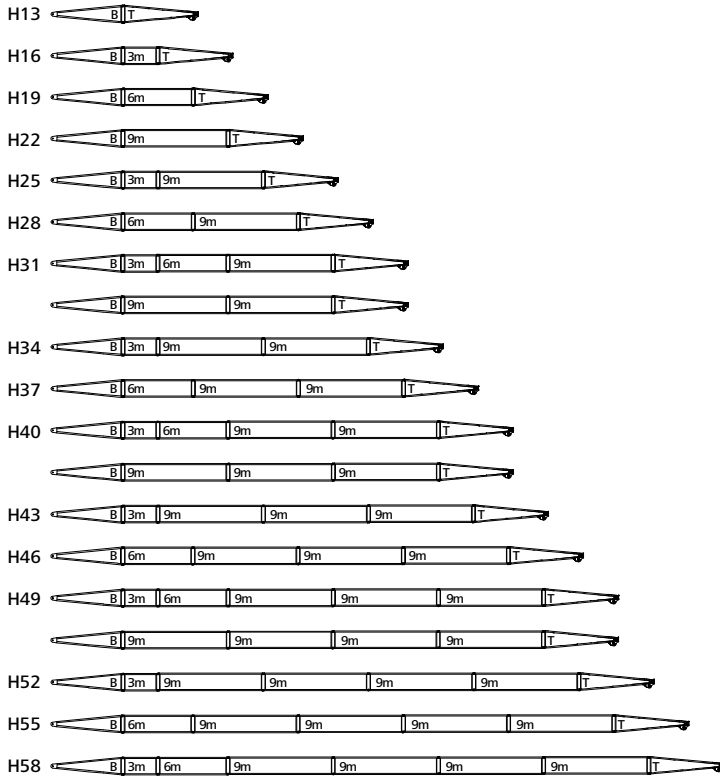



## Working Radius of HC Configuration

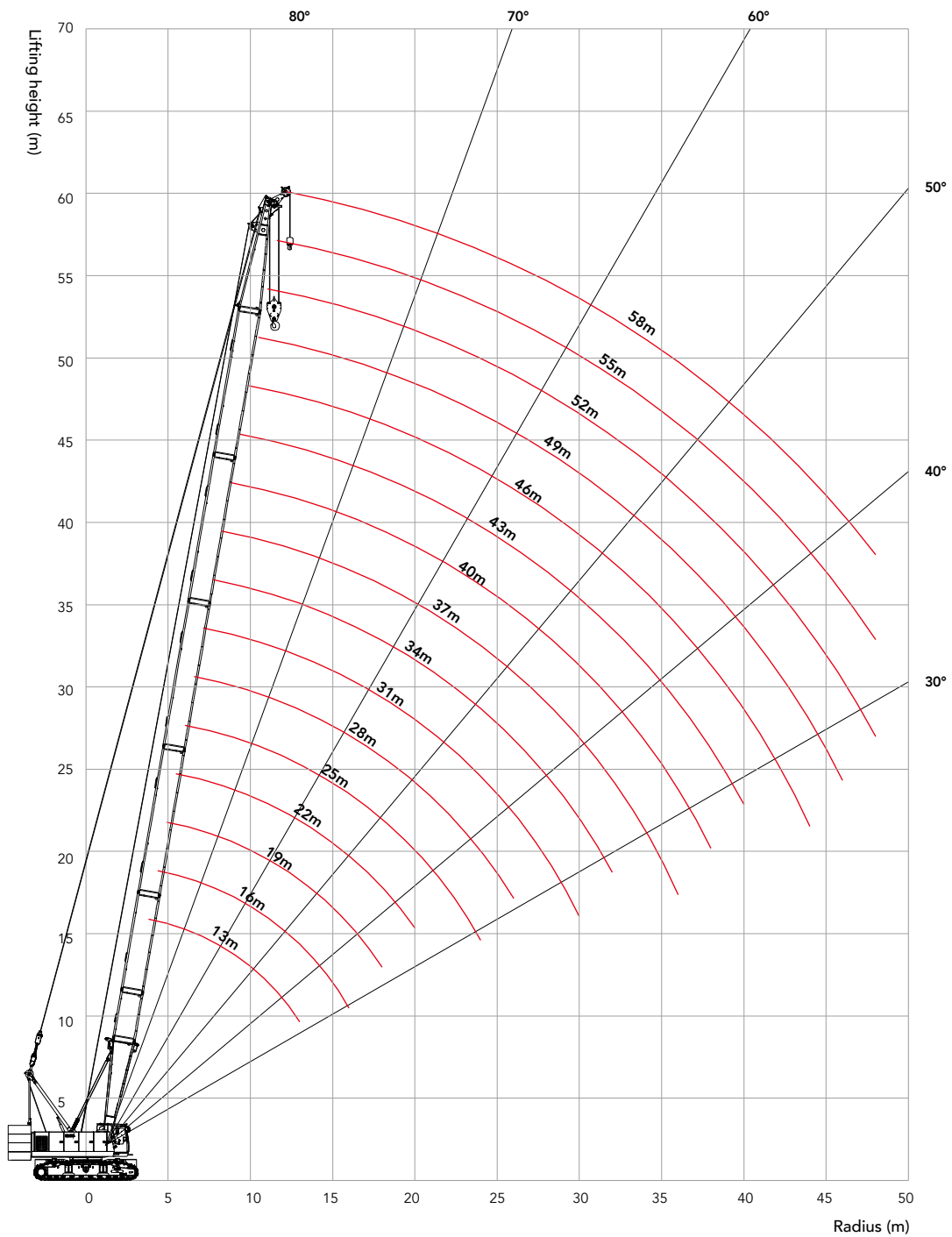

## Load Chart of HC Configuration

HC (Using Aux. Hook)																	
31.2t Rear Counterweight +11t Carbody Counterweight																	
R/BL (m)	13	16	19	22	25	28	31	34	37	40	43	46	49	52	55	58	R/BL (m)
3.8	12																3.8
4	12																4
4.5	12	12															4.5
5	12	12															5
5.5	12	12	12														5.5
6	12	12	12	12													6
6.5	12	12	12	12	12												6.5
7	12	12	12	12	12	12											7
7.5	12	12	12	12	12	12	12										7.5
8	12	12	12	12	12	12	12	12									8
9	12	12	12	12	12	12	12	12	12	12							9
10	12	12	12	12	12	12	12	12	12	12	12						10
11	12	12	12	12	12	12	12	12	12	12	12	12					11
12	12	12	12	12	12	12	12	12	12	12	12	12	12				12
13	12	12	12	12	12	12	12	12	12	12	12	12	12	12			13
14		12	12	12	12	12	12	12	12	12	12	12	12	12	12		14
15		12	12	12	12	12	12	12	12	12	12	12	12	12	12	12	15
16		12	12	12	12	12	12	12	12	12	12	12	12	12	12	12	16
18			12	12	12	12	12	12	12	12	12	12	12	12	11.9	11.7	18
20				12	11.8	11.7	11.6	11.3	11.2	11.1	10.8	10.7	10.6	10.3	10.2	10	20
22					10.4	10.3	10.1	9.9	9.8	9.7	9.4	9.3	9.2	9	8.8	8.6	22
24					9.3	9.1	9	8.8	8.6	8.5	8.3	8.2	8	7.8	7.7	7.5	24
26						8.2	8	7.8	7.7	7.6	7.3	7.2	7.1	6.9	6.7	6.5	26
28							7.2	7	6.9	6.7	6.5	6.4	6.3	6.1	5.9	5.7	28
30							6.5	6.3	6.2	6	5.8	5.7	5.6	5.4	5.2	5	30
32								5.7	5.6	5.4	5.2	5.1	5	4.8	4.6	4.4	32
34									5	4.9	4.7	4.6	4.4	4.2	4.1	3.9	34
36									4.6	4.4	4.2	4.1	4	3.8	3.6	3.4	36
38										4	3.8	3.7	3.6	3.3	3.2	3	38
40											3.4	3.3	3.2	3	2.9	2.6	40
42												3	2.8	2.6	2.5	2.3	42
44													2.7	2.5	2.3	2	44
46														2.3	2.1	1.9	46
48															1.8	1.7	48

## Working Radius of HC Configuration

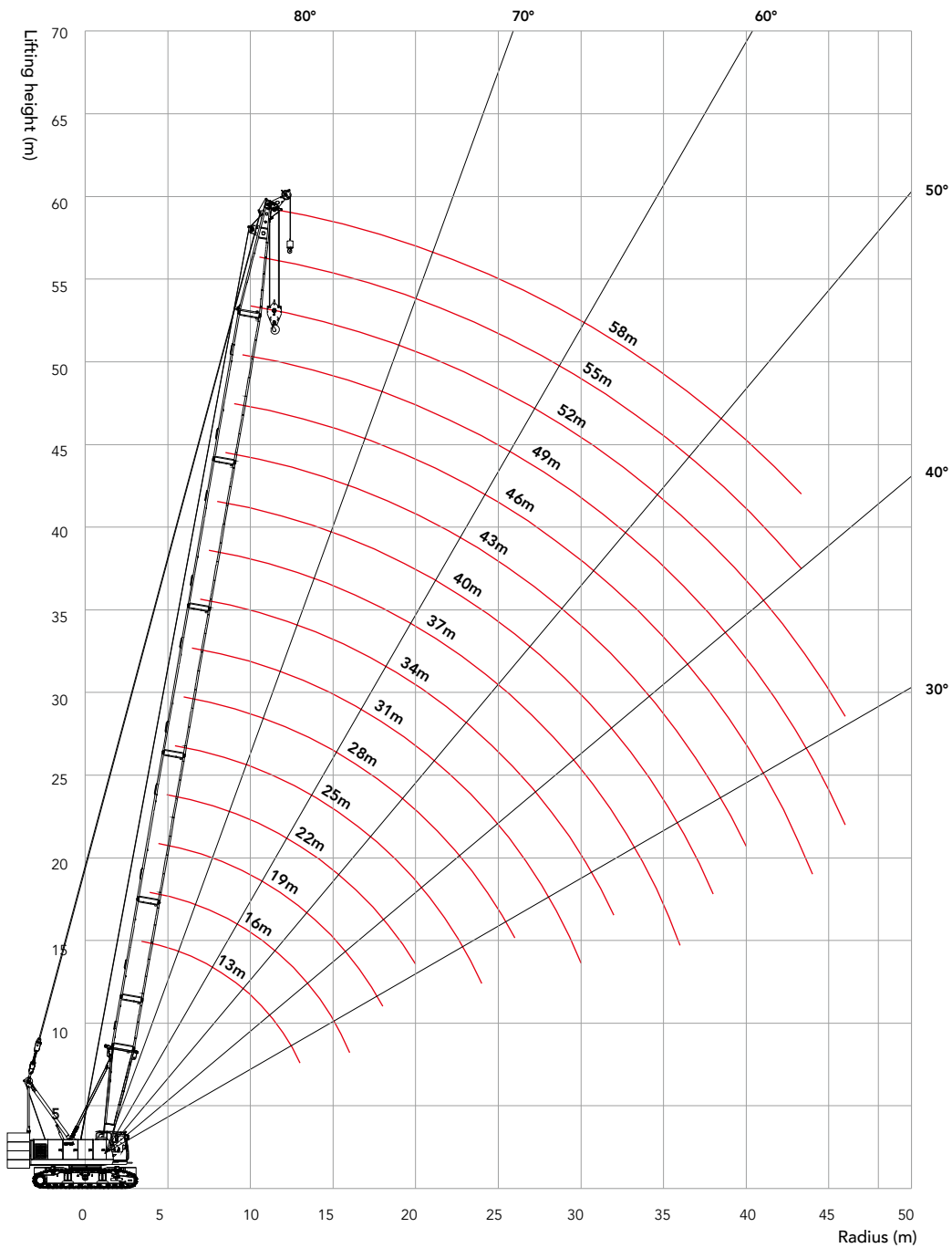

## Load Chart of HC Configuration

HC (Using Main Hook)																	
31.2t Rear Counterweight +11t Carbody Counterweight																	
R/BL (m)	13	16	19	22	25	28	31	34	37	40	43	46	49	52	55	58	R/BL (m)
3.8	99																3.8
4	89																4
4.5	83.2	81															4.5
5	74	72															5
5.5	68	67.8	67.2														5.5
6	61.9	61.2	60.4	58.2													6
6.5	54.6	54.1	53.6	52.8	51												6.5
7	48.9	48.4	48	47.6	46.6	45.2											7
7.5	44.1	43.7	43.3	43	42.6	41.7	40.5										7.5
8	40.2	39.8	39.5	39.2	38.8	38.5	37.6	36.5									8
9	34.1	33.7	33.4	33.2	32.9	32.6	32.4	31.9	31.1	30.4							9
10	29.5	29.1	28.9	28.7	28.4	28.2	27.9	27.7	27.4	26.9	26.2						10
11	25.9	25.6	25.4	25.2	24.9	24.7	24.5	24.2	24	23.8	23.5	22.9	22.4				11
12	23	22.7	22.5	22.4	22.1	21.9	21.7	21.5	21.3	21.1	20.9	20.7	20.2	19.7			12
13	20.7	20.4	20.2	20	19.8	19.6	19.4	19.2	19	18.9	18.6	18.5	18.3	17.9	17.1	15	13
14		18.5	18.3	18.1	17.9	17.7	17.5	17.3	17.2	17	16.8	16.6	16.4	16.2	15.9	14.4	14
15		16.8	16.7	16.5	16.3	16.1	15.9	15.7	15.6	15.4	15.2	15	14.9	14.6	14.5	13.8	15
16		15.4	15.3	15.1	14.9	14.7	14.6	14.3	14.2	14	13.8	13.7	13.5	13.3	13.1	12.9	16
18			13	12.8	12.6	12.5	12.3	12.1	11.9	11.8	11.6	11.4	11.3	11.1	10.9	10.7	18
20				11.1	10.8	10.7	10.6	10.3	10.2	10.1	9.8	9.7	9.6	9.3	9.2	9	20
22					9.4	9.3	9.1	8.9	8.8	8.7	8.4	8.3	8.2	8	7.8	7.6	22
24					8.3	8.1	8	7.8	7.6	7.5	7.3	7.2	7	6.8	6.7	6.5	24
26						7.2	7	6.8	6.7	6.6	6.3	6.2	6.1	5.9	5.7	5.5	26
28							6.2	6	5.9	5.7	5.5	5.4	5.3	5.1	4.9	4.7	28
30							5.5	5.3	5.2	5	4.8	4.7	4.6	4.4	4.2	4	30
32								4.7	4.6	4.4	4.2	4.1	4	3.8	3.6	3.4	32
34									4	3.9	3.7	3.6	3.4	3.2	3.1	2.9	34
36									3.6	3.4	3.2	3.1	3	2.8	2.6	2.4	36
38										3	2.8	2.7	2.6	2.3	2.2	2	38
40											2.4	2.3	2.2	2	1.9	1.6	40
42												2	1.8	1.6	1.5	1.3	42
44													1.7	1.5	1.3	1	44
46														1.3	1.1		46

Note: all the values provided in this material are subject to update without prior notice.





## Zhejiang Sany Equipment Co.,LTD

SANY Crawler Crane Industrial Park, No. 2188 Daishan Road, Wuxing District, Huzhou City,  
Zhejiang Province, P. R. China Zip 313028  
Consulting [sanycrane@sanygroup.com](mailto:sanycrane@sanygroup.com) (Crane BU) / [crd@sany.com.cn](mailto:crd@sany.com.cn) (IHQ)  
After-sales Service 0086-400 6098 318

**Reminder:**

Any change in the technical parameters and configuration due to product modification or upgrade may occur without prior notice.  
The machine in the picture may include additional equipment. This brochure is for reference only, and goods in kind shall prevail.  
Copyright at SANY. No part of this brochure may be copied or used for any purpose without written approval from SANY.

© Edited in November 2022

